

YOUNG 2.0

Design minimal e lineare dal semplice mantenimento.

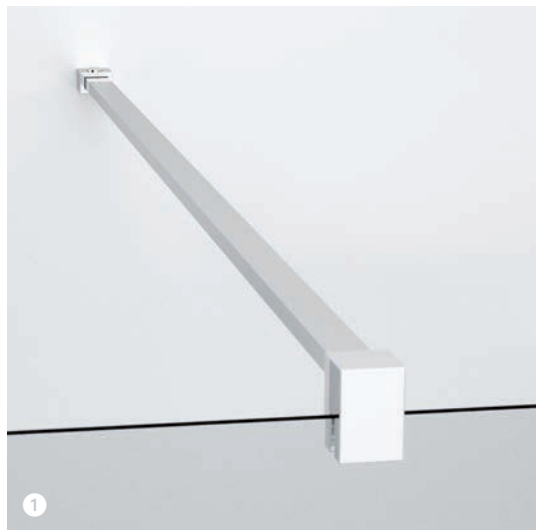

- 1 Nuova barra di sostegno a muro. 2 Maniglia in metallo cromato.
3 Doppia cerniera di sollevamento, porte reversibili. 4 Possibilità di apertura interno/esterno.

TRATTAMENTI



TRATTAMENTO ANTIGOCCIA
Cristalli sempre brillanti, facili da pulire.
Impedisce la formazione del calcare e dei batteri.
Solo su vetri trasparenti.



FINITURA CROMO E ORO PVD
Ciclo di produzione integrata a zero emissioni, 100% ecologico. Anticalcare, resistente all'azione batterica, ecologica brillantezza resistente nel tempo.

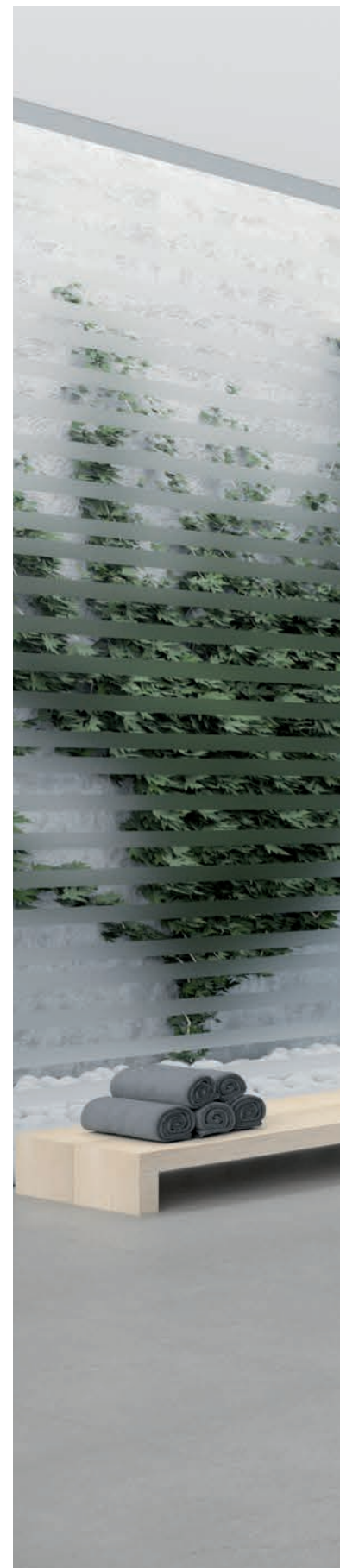

YOUNG 2.0 1B

PORTA DOCCIA, APERTURA 1 ANTA BATTENTE

Installabile in nicchia o abbinabile a fisso laterale YOUNG 2.0 F1B

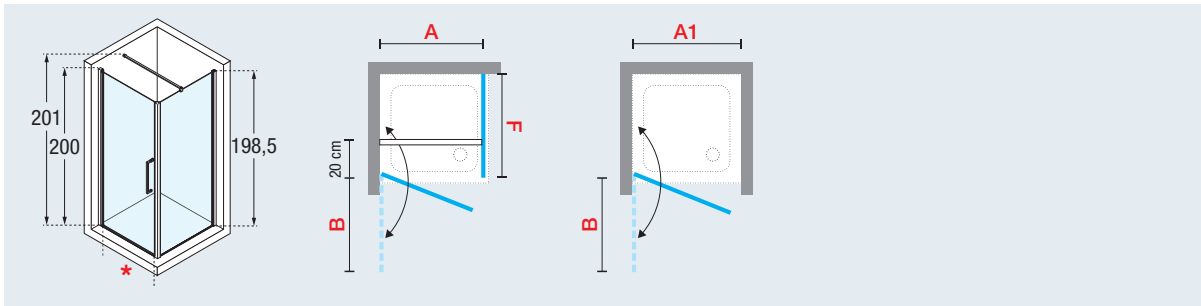

Misure				Codice	Scelta Vetro				Scelta Profilo / Prezzo			
Misura effettiva d'ingombro		Entrata	Ingombro anta esterna		1	2	4	72	D	B	K	O
Con fisso	In nicchia											

PORTA

A	A1	*	B	Codice	Trasparente	Aqua	Satin	Victoriana oro	Bianco	Silver	Cromo	Oro
58 ↔ 62	57 ↔ 61	47	48	Y2 1B 57-	●							
68 ↔ 72	67 ↔ 71	57	58	Y2 1B 67-	●							
73 ↔ 77	72 ↔ 76	62	63	Y2 1B 72-	●							
78 ↔ 82	77 ↔ 81	67	68	Y2 1B 77-	●							
88 ↔ 92	87 ↔ 91	77	78	Y2 1B 87-	●							
98 ↔ 102	97 ↔ 101	87	88	Y2 1B 97-	●							
H 140 ↓ 200 L 57 ↔ 99				SPECIAL Y2 1B SP								

FISSO

F	A	A1	*	B	Codice	Trasparente	Aqua	Satin	Victoriana oro	Bianco	Silver	Cromo	Oro
57 ↔ 59	-	-	-	-	Y2 F1B 57-								
59 ↔ 61	-	-	-	-	Y2 F1B 59-								
65 ↔ 67	-	-	-	-	Y2 F1B 65-								
67 ↔ 69	-	-	-	-	Y2 F1B 67-	●							
69 ↔ 71	-	-	-	-	Y2 F1B 69-								
73 ↔ 75	-	-	-	-	Y2 F1B 73-								
75 ↔ 77	-	-	-	-	Y2 F1B 75-								
77 ↔ 79	-	-	-	-	Y2 F1B 77-	●							
79 ↔ 81	-	-	-	-	Y2 F1B 79-								
85 ↔ 87	-	-	-	-	Y2 F1B 85-								
87 ↔ 89	-	-	-	-	Y2 F1B 87-	●							
89 ↔ 91	-	-	-	-	Y2 F1B 89-	●							
95 ↔ 97	-	-	-	-	Y2 F1B 95-								
97 ↔ 99	-	-	-	-	Y2 F1B 97-	●							
99 ↔ 101	-	-	-	-	Y2 F1B 99-								
117 ↔ 119	-	-	-	-	Y2 F1B 117-								
119 ↔ 121	-	-	-	-	Y2 F1B 119-								
* H 140 ↓ 200 L 20 ↔ 120				SPECIAL Y2 F1B SP									

ESEMPIO COMPILAZIONE CODICE:

Y21B57-1D

=

Y21B57-

+

1

+

D

* Il fisso speciale deve essere ordinato della stessa altezza totale della porta

● Disponibilità indicativa deposito centrale 7gg.





200 cm



6 mm



porta 4 cm
fisso 2 cm



p. 79



APERTURA INTERNO-ESTERNO



OPTIONAL



Barra di sostegno ad angolo

Misure	Codice	Prezzo	
		cromo	oro
15 cm	R80LOU150-	K	O
25 cm	R80LOU250-		
35 cm	R80LOU350-		
45 cm	R80LOU450-		

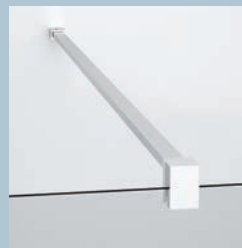

Barra di sostegno 150 cm

Finitura	Codice	Prezzo
bianco	R80Y215-D	
silver	R80Y215-B	
cromo	R80Y215-K	
oro	R80Y215-O	



Kit barra orientabile

- 1 barra orientabile da 100 cm (accorciabile)
- 1 attacco a muro
- 1 morsetto di fissaggio al vetro

Finitura	Codice	Prezzo
Bianco	R80KUOR100-D	
Silver	R80KUOR100-B	
Cromo	R80KUOR100-K	



Kit barra a "T"

barra di sostegno 150 cm da abbinare alla barra in dotazione per soluzione a T

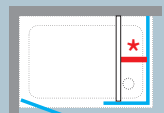

Finitura	Codice	Prezzo
bianco	R80Y215T-D	
silver	R80Y215T-B	
cromo	R80Y215T-K	
oro	R80Y215T-O	

DATI TECNICI

VETRO TEMPRATO 6 mm (European standards UNI EN 14428)

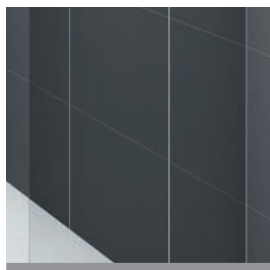

trasparente
COD. 1



aqua
COD. 2



satin
COD. 4

SERIGRAFIA

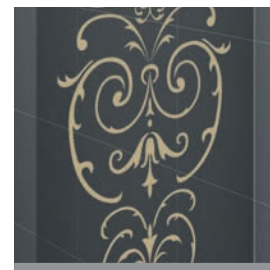

victoriana oro
(vernice dorata)
COD. 72

(solo per i modelli 2G, G+F,
1B, R2 LUX)

FINITURA PROFILI



bianco
COD. D



silver
COD. B



cromo
COD. K

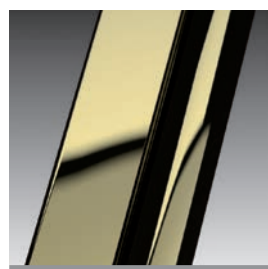

oro
COD. O



(solo per i modelli 2G, G+F, 2A,
2B, F2B, G+F in linea, 1B, F1B,
A, R, R2, R1 SWIM, R2 LUX)

MANIGLIA



maniglia in metallo
cromato.
interasse 384mm

MISURE DI INGOMBRO PROFILI DI FISSAGGIO

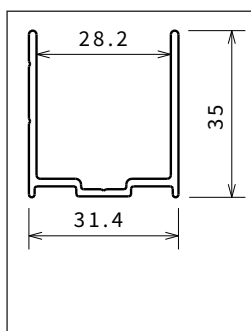

a muro

Altezza	Finitura	Codice
1984	Bianco	P01BNMOBST-A
1984	Silver	P01BNMOBST-B
1984	Cromo	P01BNMOBST-K
1984	Oro	P01BNMOBST-O
2000	Bianco	P01BNMOAST-A
2000	Silver	P01BNMOAST-B
2000	Cromo	P01BNMOAST-K
2000	Oro	P01BNMOAST-O

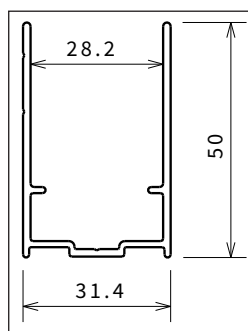

compensativi

Altezza	Finitura	Codice
1984	Bianco	P05Y2ST-A
1984	Silver	P05Y2ST-B
1984	Cromo	P05Y2ST-K
1984	Oro	P05Y2ST-O
2000	Bianco	P05Y2ST2-A
2000	Silver	P05Y2ST2-B
2000	Cromo	P05Y2ST2-K
2000	Oro	P05Y2ST2-O

Per ulteriori informazioni sui profili, vedi pag. 332

COME RILEVARE LE MISURE

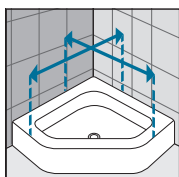
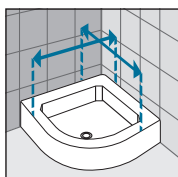
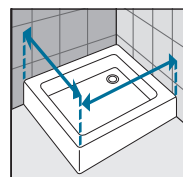

Rilevare le misure da muro a bordo esterno del piatto doccia. Le misure devono essere rilevate sulla parete finita, a rivestimenti posati, secondo gli schemi riportati.

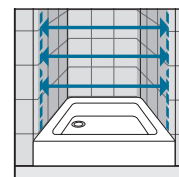

Rilevare le misure da muro a muro, in basso, in alto, al centro e utilizzare quella di valore inferiore. Le misure devono essere rilevate sulla parete finita, a rivestimenti posati, secondo gli schemi riportati.