

# Kinedo

## ICONIK 03

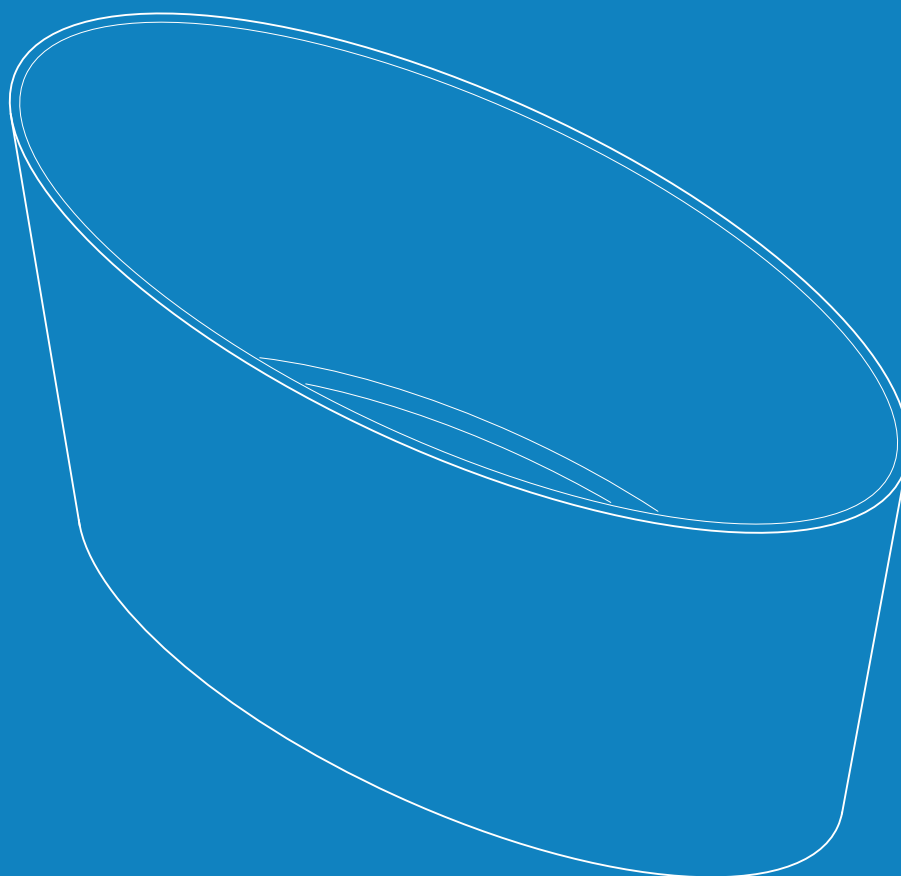

**ISTRUZIONI  
INSTALLAZIONE, USO E MANUTENZIONE**



**INSTRUCTIONS  
INSTALLATION, USE AND MAINTENANCE**





# Kinedo



**Vi ringraziamo per aver scelto  
un nostro prodotto**

***We thank You for choosing  
one of our products***

## **Indice - Index**

- **Dati tecnici e ingombri. .... Pag. 4**  
- ***Technical data and overall dimensions***
- **Prima dell'installazione ..... Pag. 5**  
- ***Before installation***
- **Pre-installazione ..... Pag. 6**  
- ***Pre-installation***
- **Piletta con click clack e troppo pieno automatico . . Pag. 7**  
- ***Click clack waste with automatic overflow***
- **Sequenza di installazione . .... Pag. 8**  
- ***Installation sequence***
- **Utilizzo della vasca. .... Pag.10**  
- ***Use of the bathtub***
- **Funzionamento "troppopieno" . .... Pag.11**  
- ***"Overflow" functioning***
- **Pulizia vasca ..... Pag.12**  
- ***Bathtub cleaning***
- **Pulizia piletta click-clack . .... Pag.13**  
- ***Click-clack drain cleaning***
- **KIT di riparazione ..... Pag.14**  
- ***Repair KIT***



Versione "unica" - "Single" version



Senza sistema  
Without system



Superficie antibatterica  
Antibacterial surface



Troppopieno  
Overflow

NO!



Piletta anti debordo  
Anti overflow drain

OK!

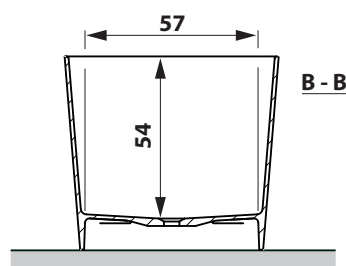
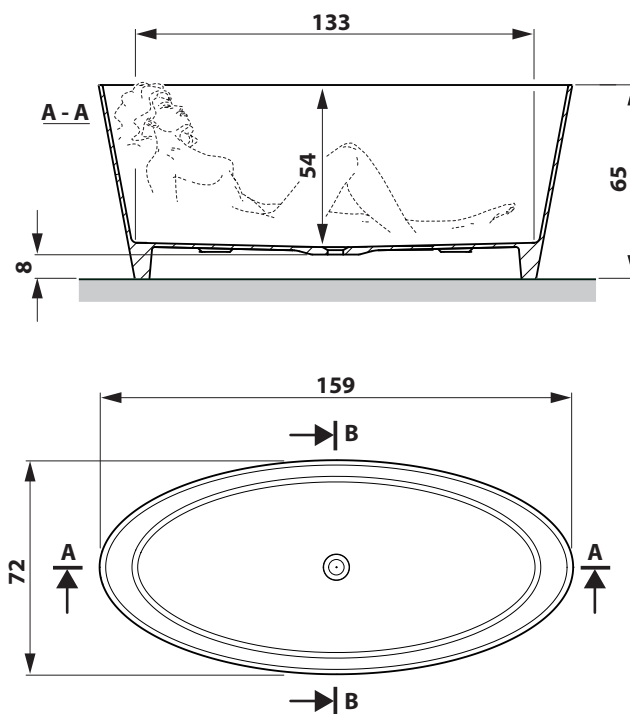

Dimensioni in "cm" (tolleranza  $\pm 5$ mm) - Dimensions in "cm" (tolerance  $\pm 5$ mm)

DATI TECNICI	TECHNICAL DATA	
• Tensione	• Voltage	---
• Frequenza	• Frequency	---
• Potenza totale assorbita	• Total power absorption	---
• Corrente massima	• Max current	---
• Allaccio acqua fredda e calda	• Cold and hot water fittings	---
• Scarico acqua	• Water waste trap	$\varnothing 40$ mm
• Dimensioni vasca	• Bathtub dimensions	159 x 72 x h65 cm
• Capacità acqua	• Water volume	400 l
• Spessore minimo vasca	• Minimum bathtub thickness	1,3 cm
• Altezza interna vasca (filo bordo)	• Bathtub internal height (flush with the edge)	54 cm
• Peso a vuoto	• Empty weight	84,5 kg
• Durevole nel tempo	• Durable over time	Si / Yes
• Temperatura acqua costante	• Constant water temperature	Si / Yes
• Piletta Iconik (di serie)	• Iconik drain (standard)	Si / Yes
• Sifone	• Siphon	Non fornita / Not supplied
• Rubinetteria	• Tap	Non fornita / Not supplied
• Ottima capacità di trattenere il calore, con una temperatura ambiente di 22° l'acqua in 60 minuti passa da 55° a 47°. • Excellent ability to retain heat, with an ambient temperature of 22° the water goes from 55° to 47° in 60 minutes.		

**IMPORTANTE**

Prima di iniziare l'installazione leggere il presente libretto istruzioni.

**IMPORTANT**

Read the following instruction manual before starting installation.



- Dopo aver rimosso i componenti dagli imballi, verificare visivamente che gli stessi non presentino difetti.
- Qualsiasi difetto deve essere segnalato al fornitore prima dell'assemblaggio delle varie parti e dell'installazione.
- Qualsiasi reclamo relativo a imperfezioni del prodotto sarà accettato **SOLO** se segnalato prima dell'assemblaggio delle varie parti e dell'installazione.

Verificare la presenza di tutti i componenti prima di iniziare il montaggio.

- After removing the components from packaging, visually check they do not show any defect.
- Any defect must be reported to the supplier before assembling the various parts and before installation.
- Any complaint related to imperfections of the product will be accepted **ONLY** if reported before assembling the various parts and before installation.

Check for the presence of all components before assembly.

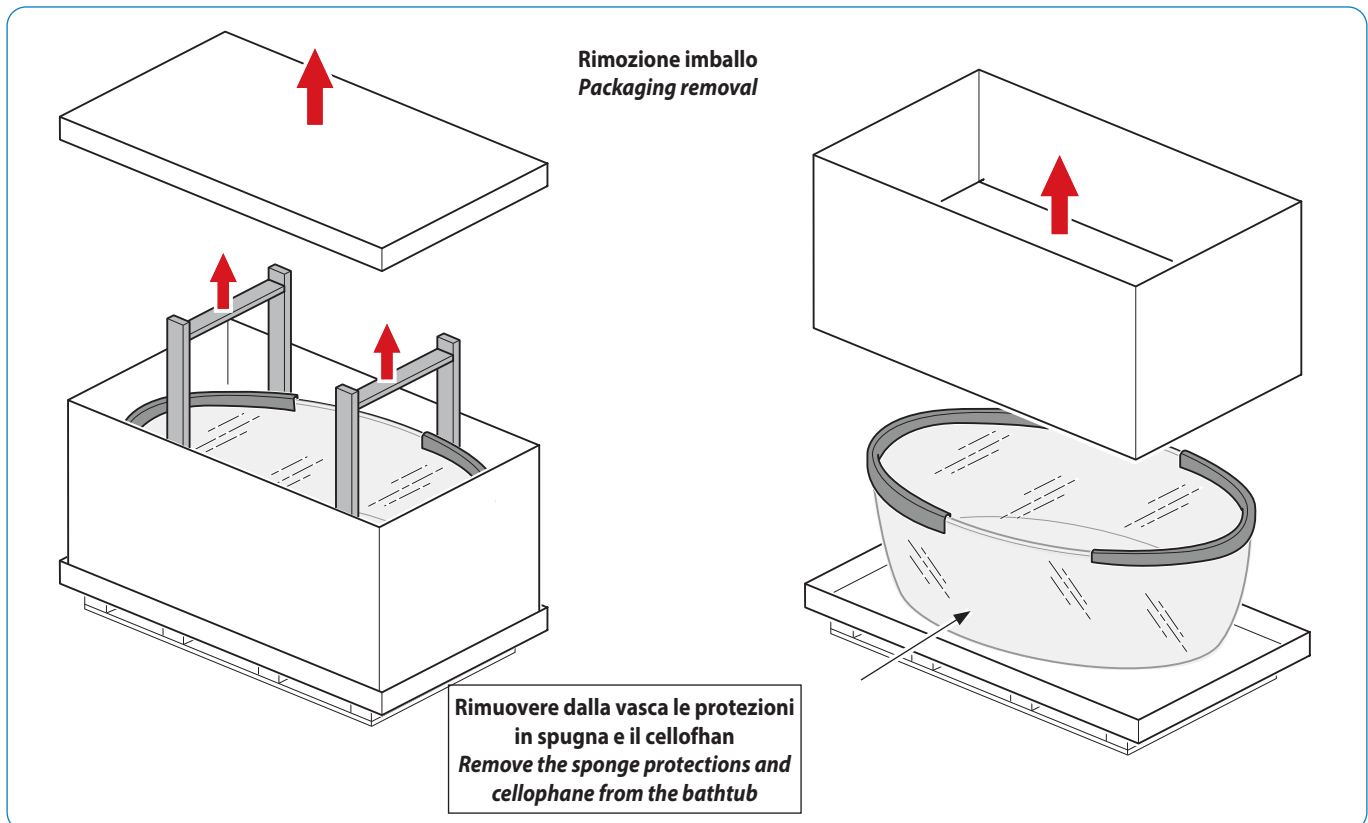

**Gli elementi dell'imballaggio non devono essere lasciati alla portata dei bambini in quanto potenziali fonti di pericolo.  
The packaging materials must not be left within reach of children as they can be dangerous.**

INSTALLAZIONE CONTRO ALLA PARETE  
INSTALLATION AGAINST THE WALL

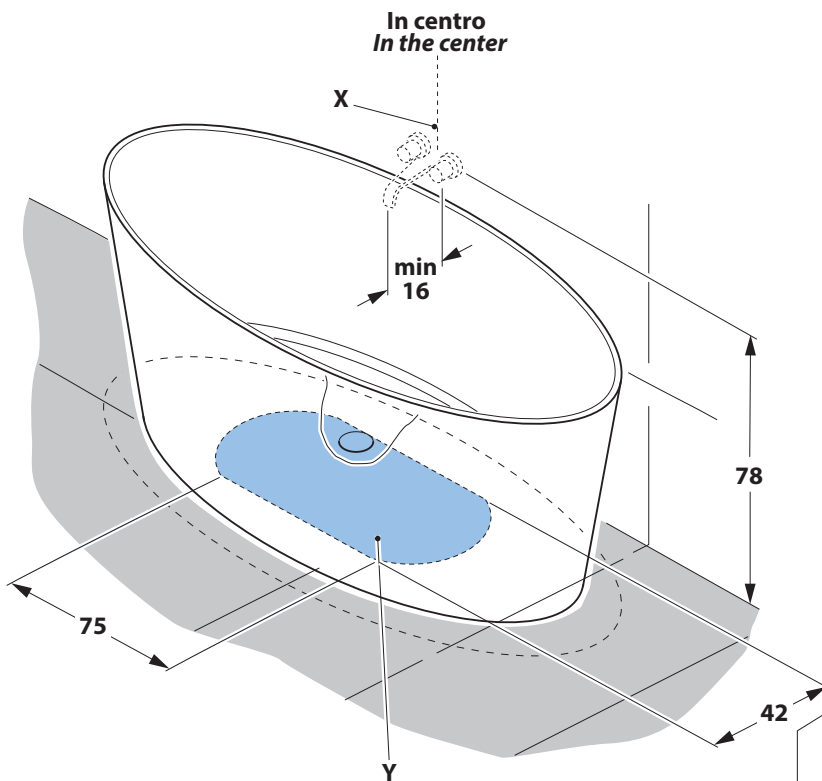

X Area per installazione rubinetteria a parete  
Area for wall installation of taps

Y Area per scarico a pavimento  
Area for floor drain

Z Area per installazione rubinetteria a piantana  
Area for floorstanding installation of taps

V Scarico a pavimento da  $\varnothing 40$  mm  
 $\varnothing 40$  mm floor drain

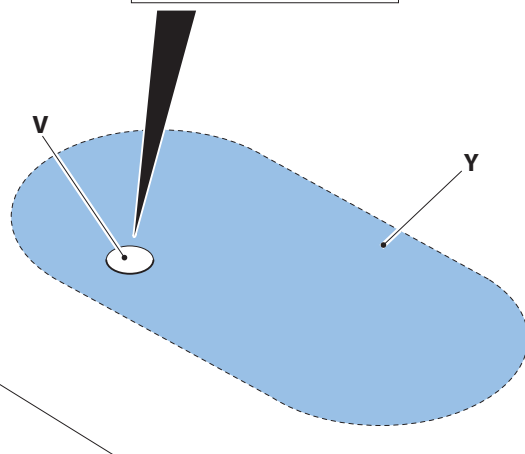
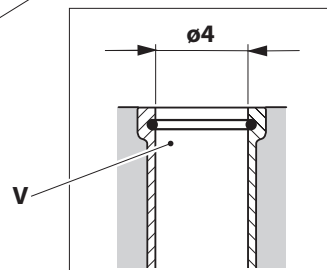
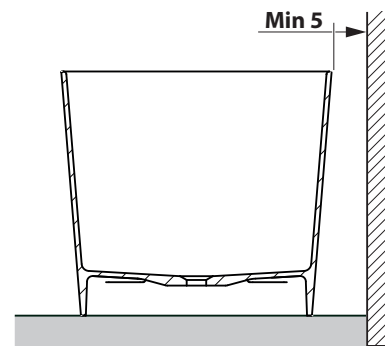

INSTALLAZIONE IN CENTRO AL LOCALE  
INSTALLATION IN THE MIDDLE OF THE ROOM

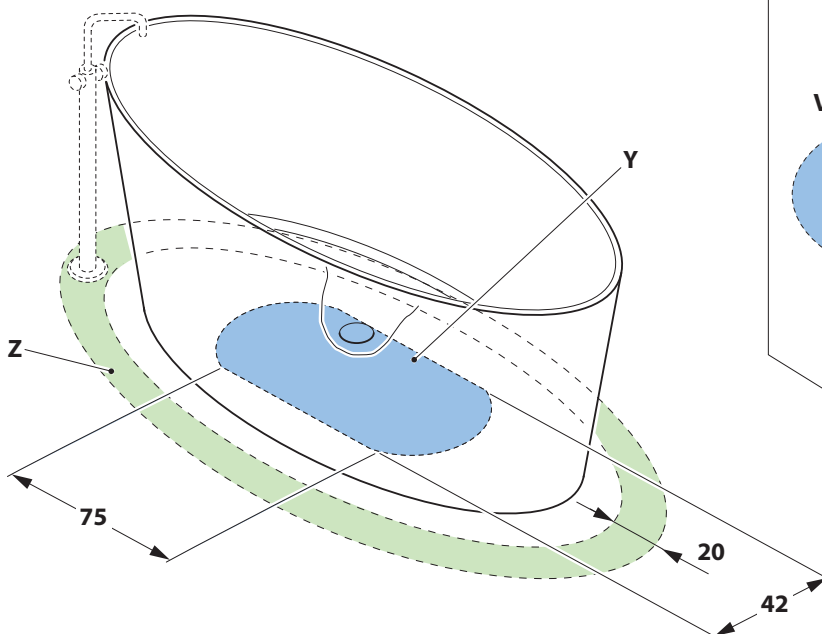

Dimensioni in "cm" (tolleranza  $\pm 5$ mm) - Dimensions in "cm" (tolerance  $\pm 5$ mm)

**IL COSTRUTTORE NON E' RESPONSABILE PER I DANNI DOVUTI AD UNA ERRATA O NON CONFORME INSTALLAZIONE.**

**IN NO EVENT SHALL THE MANUFACTURER BE LIABLE FOR ANY DAMAGES WHATSOEVER THAT MAY ARISE FROM INAPPROPRIATE AND NON-COMPLIANT INSTALLATION PROCEDURES.**

I dati e le caratteristiche indicate non impegnano IL COSTRUTTORE, che si riserva il diritto di apportare tutte le modifiche ritenute opportune senza obbligo di preavviso o sostituzione  
Neither the information nor the characteristics reported are binding for THE MANUFACTURER, which reserves the right to make any improvements, as deemed necessary, without notice or with no liability to replacement.

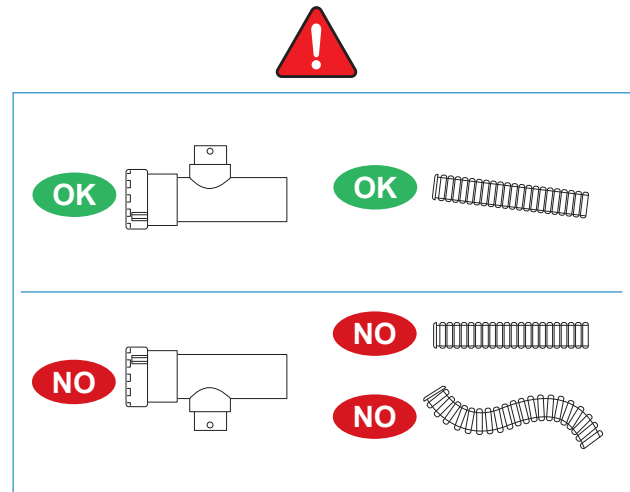
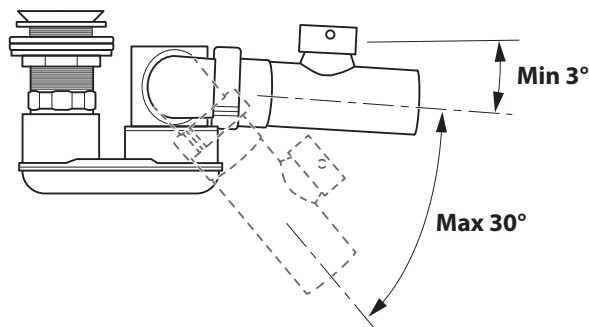
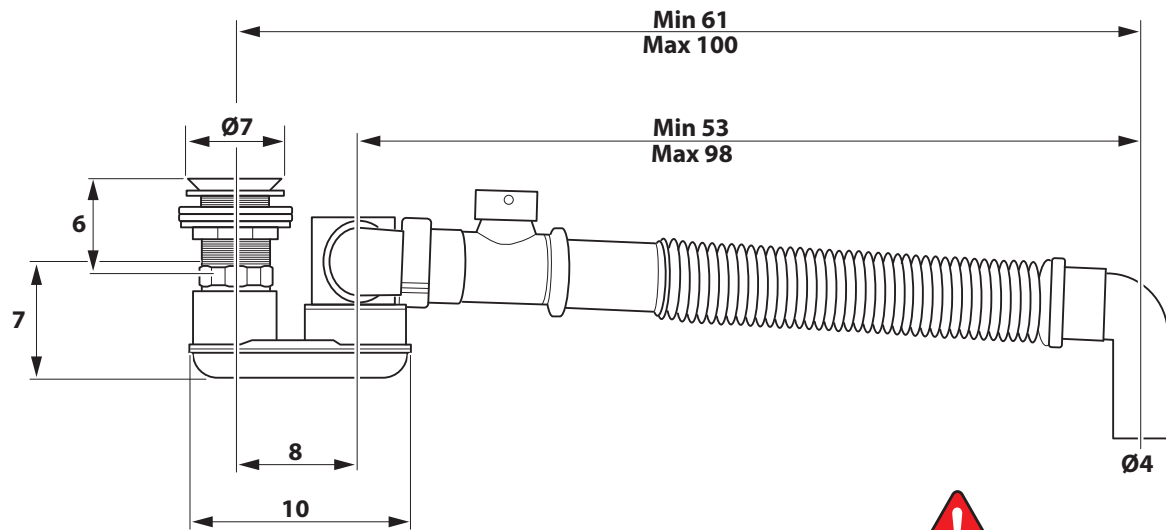
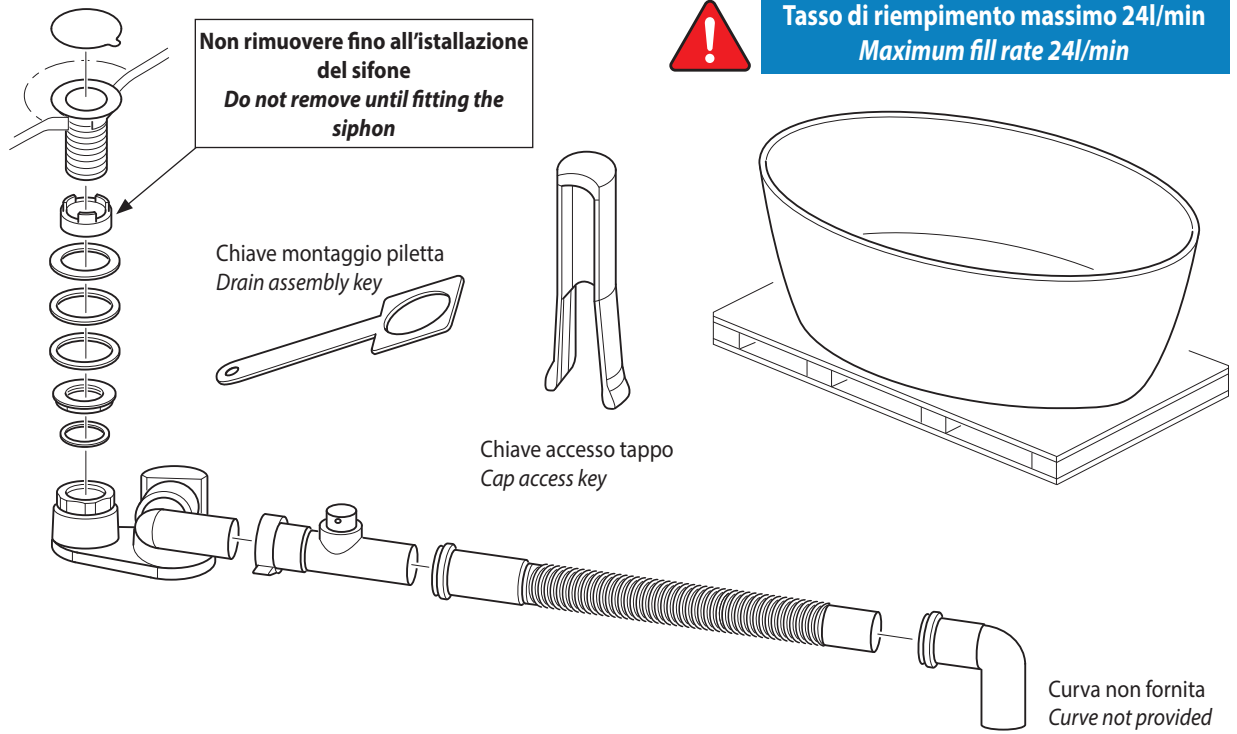

84,5kg (± 5)

3

Posizionare la vasca nel punto di installazione  
Place the bathtub in the installation point

Sollevare la vasca e posizionare dei supporti  
Lift the bathtub and place supports

MAX. 40°

Assicurarsi che la vasca non possa cadere  
Make sure the bathtub can not fall

		<p>Aperto Open</p> <p>Chiuso Closed</p>
<p>Rimuovere Remove</p>	<p>Opzione 1 Option 1</p> <p>Opzione 2 Option 2</p>	

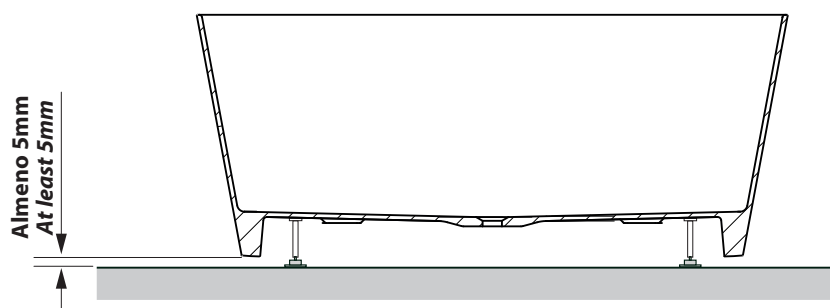
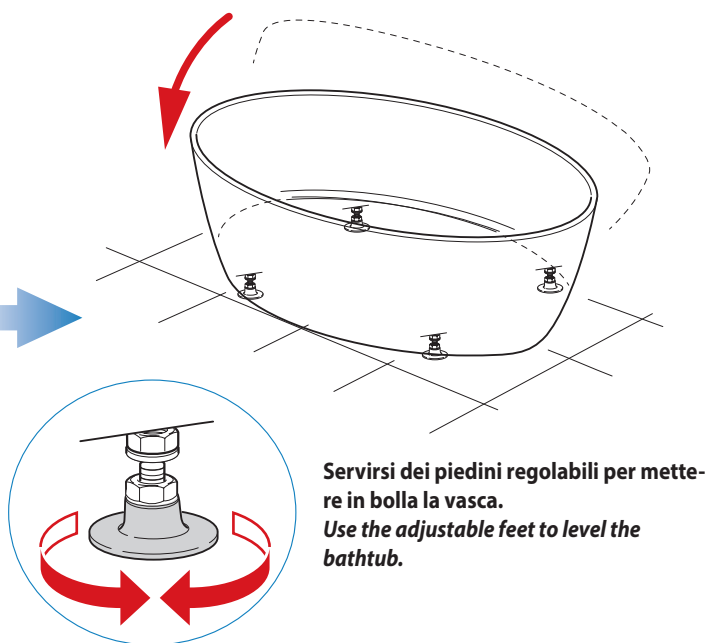
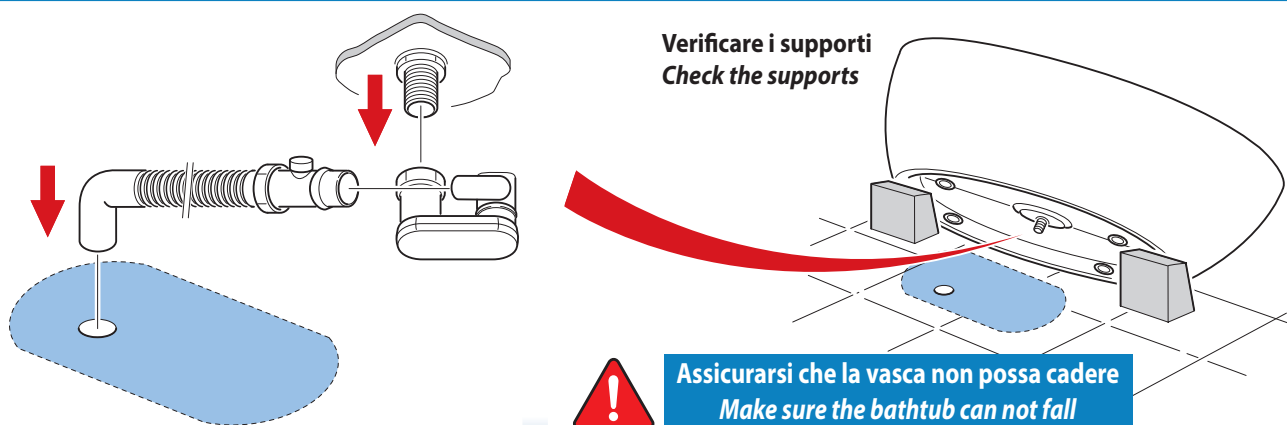

**Installare la vasca verificando che sia perfettamente a livello tanto nel senso della lunghezza che in quello della larghezza!**  
*Install the bathtub making sure it is perfectly level both in the length and in the width!*

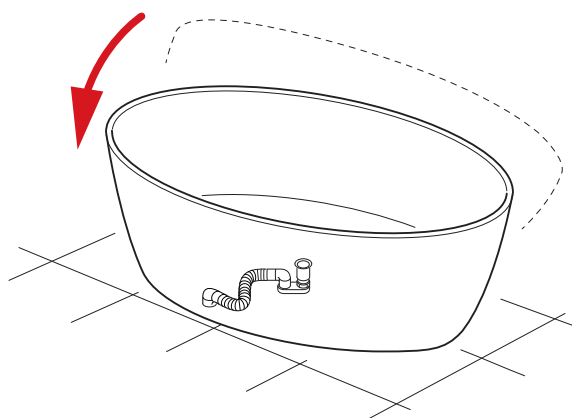

**Assicurarsi che il tubo flessibile non si pieghi in modo anomalo**  
*Make sure the flexible hose does not bend abnormally*



Prima di ogni utilizzo lasciare scorrere l'acqua per 15 secondi prima di chiudere il tappo  
Before every single use leave water flushing for 25 seconds before closing the valve

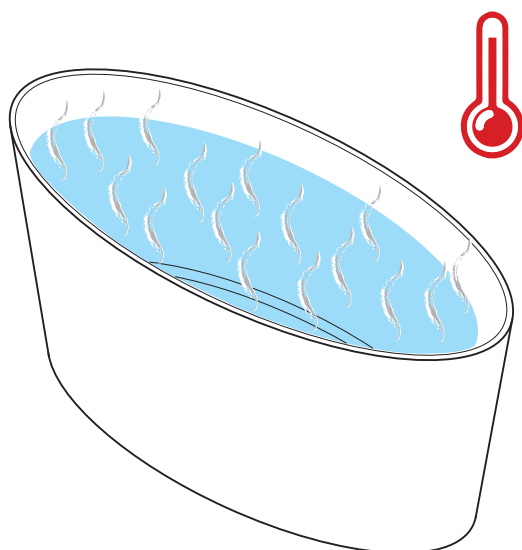
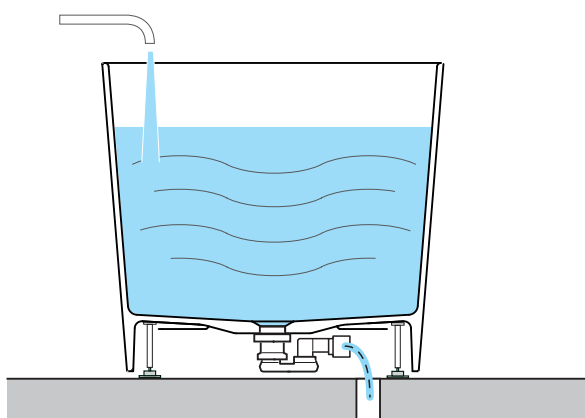
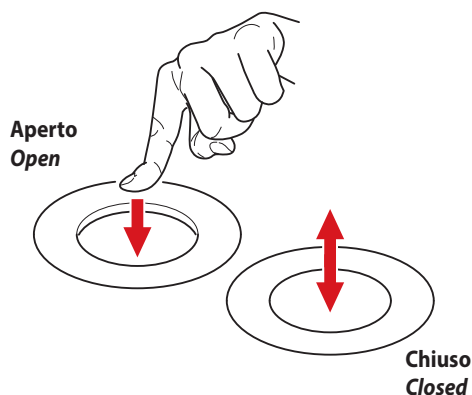
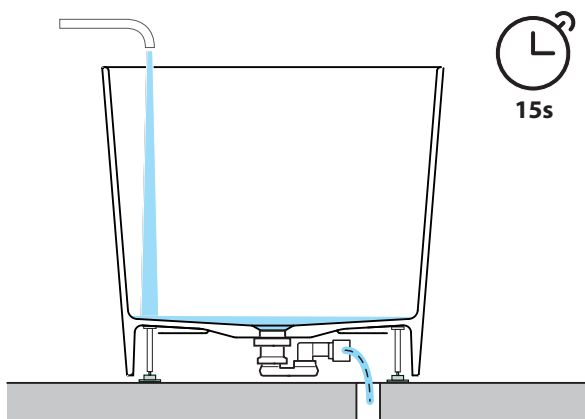
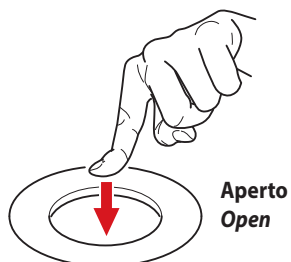

La pietra dolomitica assorbe e trattiene il calore mantenendo la temperatura dell'acqua per almeno 60 minuti.  
The dolomite stone absorbs and retains heat, maintaining the water temperature for at least 60 minutes.

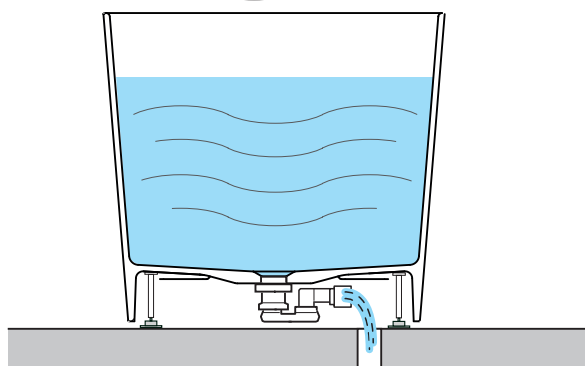
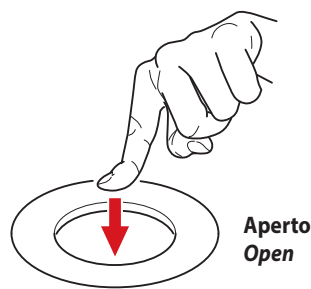

Terminato l'utilizzo della vasca, scaricare l'acqua aprendo la piletta clik-clack.  
After using the bathtub, drain the water by opening the clik-clack drain.



Piletta click-clack con sistema di sicurezza.  
Si attiva quando il livello dell'acqua nella vasca raggiunge il limite massimo, evitando la fuoriuscita dell'acqua.

*Click-clack drain with safety system.  
It is activated when the water level in the bathtub reaches the maximum limit, preventing the water from escaping.*

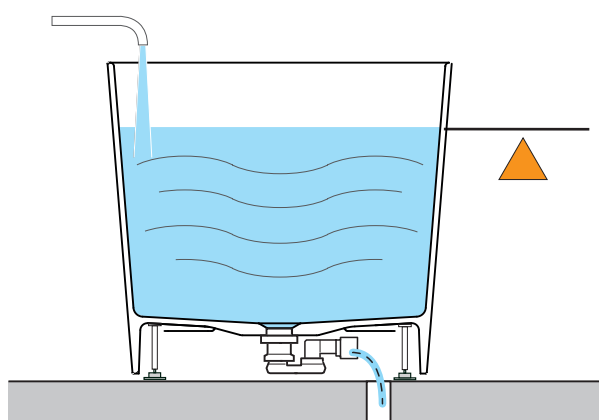
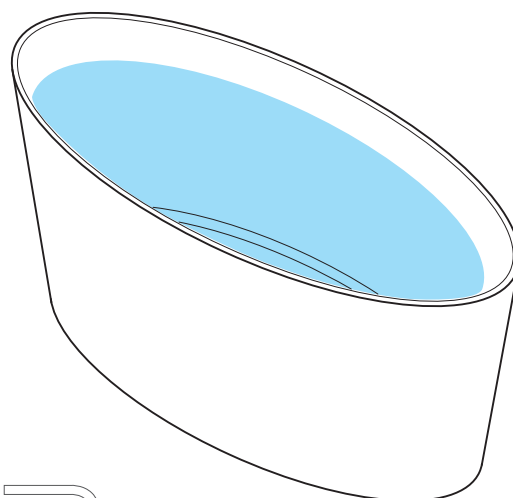

- 1.** Quando l'acqua raggiunge il **livello di apertura prestabilito**, si attiva il sistema di sicurezza aprendo gradualmente la piletta  
*When water reaches the **preset level of opening**, the safety system activates gradually opening the drain*

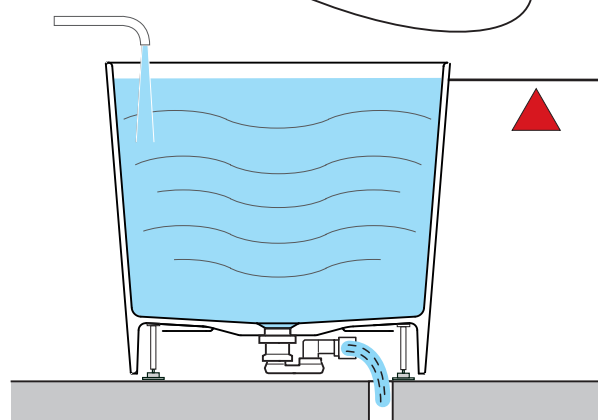

- 2.** Fino alla completa apertura della piletta, il livello dell'acqua continua ad aumentare fino ad arrivare al **livello di sicurezza** prestabilito.  
*Until complete opening of the drain, the water level continues to increase until it reaches the preset **safety level**.*

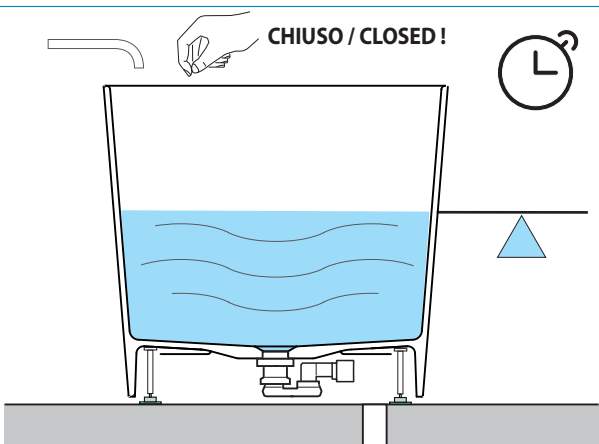

- 4.** Dopo aver chiuso l'acqua, trascorsi alcuni minuti, l'acqua raggiunge il livello minimo prestabilito e la piletta si chiude.  
*After closing water, after a few minutes have passed, water reaches the preset minimum level and the drain closes.*

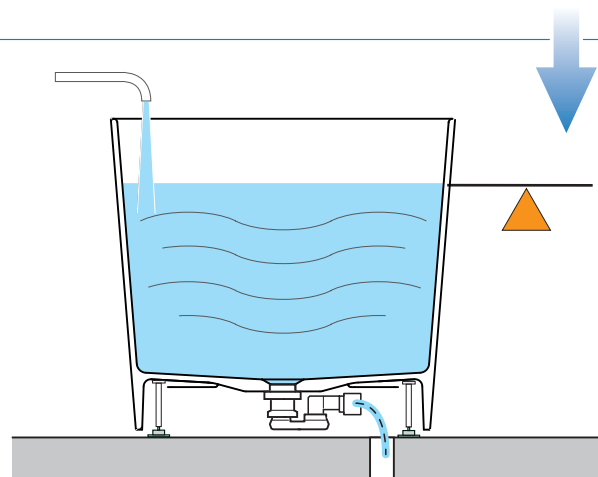

- 3.** Anche con il rubinetto aperto, l'acqua non deborda perchè la piletta rimane aperta fino a quando non si chiude il rubinetto.  
*Even with tap open, water does not overflow since the drain remains open until the tap is closed.*

- Dopo l'uso risciacquare con acqua corrente. I residui dei prodotti per la pulizia personale, sapone, shampoo, doccia schiuma, etc. possono causare danni; sciacquare abbondantemente.
- Pulire la vasca utilizzando solamente spugne per piatti (solo dal lato morbido), spugne corpo, panni morbido o spazzole morbida. Non utilizzare panni in microfibra.
- Per una pulizia regolare utilizzare un detergente universale con proprietà non abrasive, oppure acqua e sapone per stoviglie non abrasivo. Dopo ogni utilizzo la superficie interna deve essere risciacquata con acqua e asciugata con un panno di cotone morbido.
- After use, rinse with running water. Residues from personal cleaning products, soap, shampoo, shower gel, etc. can cause damage; rinse thoroughly.
- Clean the tub using only dish sponges (soft side only), body sponges, soft cloths or soft brushes. Do not use microfiber cloths.
- For regular cleaning, use an universal detergent with non-abrasive properties, or water and non-abrasive dish soap. After each use, the internal surface must be rinsed with water and dried with a soft cotton cloth.

**Il calcare può essere trattato semplicemente con una soluzione di acqua e aceto.**

**Limescale can be treated simply with a solution of water and vinegar.**



**Evitare assolutamente l'utilizzo di tutti i prodotti che contengono abrasivi!**



**Absolutely avoid using all products that contain abrasives!**

**Rimozione delle macchie difficili**  
**Difficult stains removal**

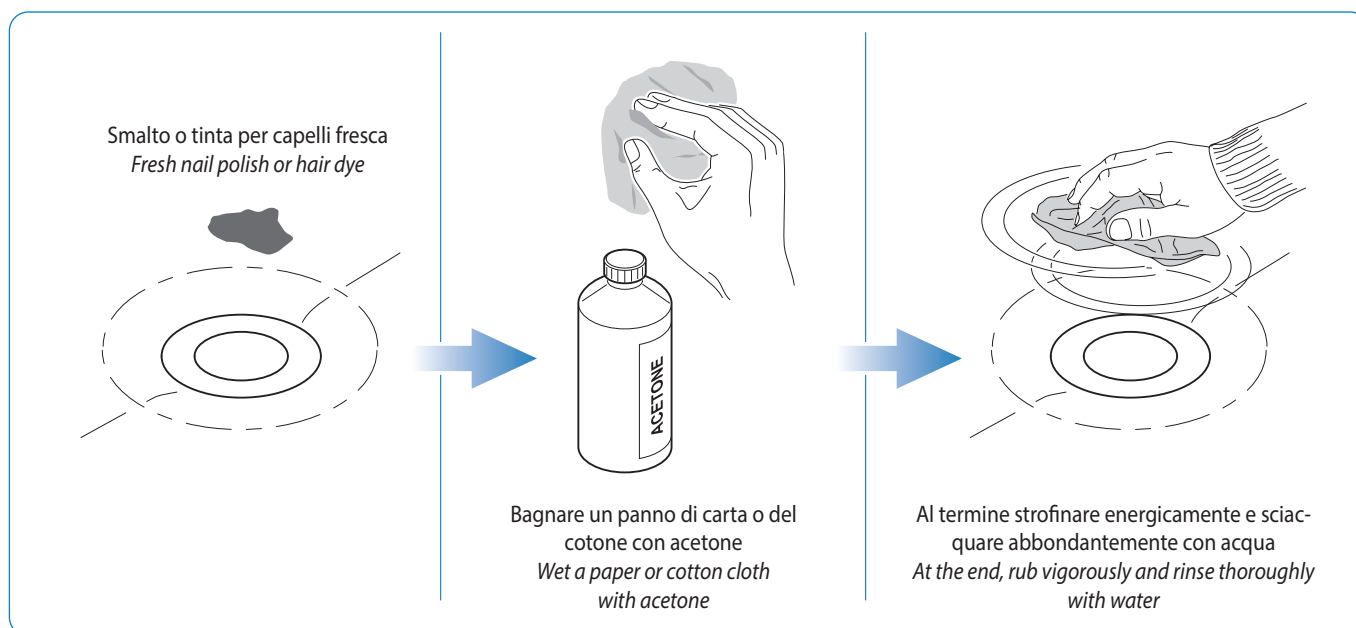

- Per le macchie più ostinate (macchie di grasso, olio, vernice o inchiostro), utilizzare un detergente delicato abrasivo. Potrebbe essere necessario un pò più di strofinamento per rimuovere efficacemente le macchie.
- Le macchie di tintura per capelli essiccate non possono essere rimosse totalmente con acetone o alcool. Effettuare una leggera levigatura con spugna abrasiva fine o carta vetrata di grana 3000. Poi impregnare con olio idratante per bambini.
- For stubborn stains (grease, oil, paint or ink stains), use a mild abrasive cleaner. A little more scrubbing may be required to effectively remove stains.
- Dried hair dye stains cannot be totally removed with acetone or alcohol. Lightly sand with a fine abrasive sponge or 3000-grit sandpaper. Then soak with moisturizing baby oil.

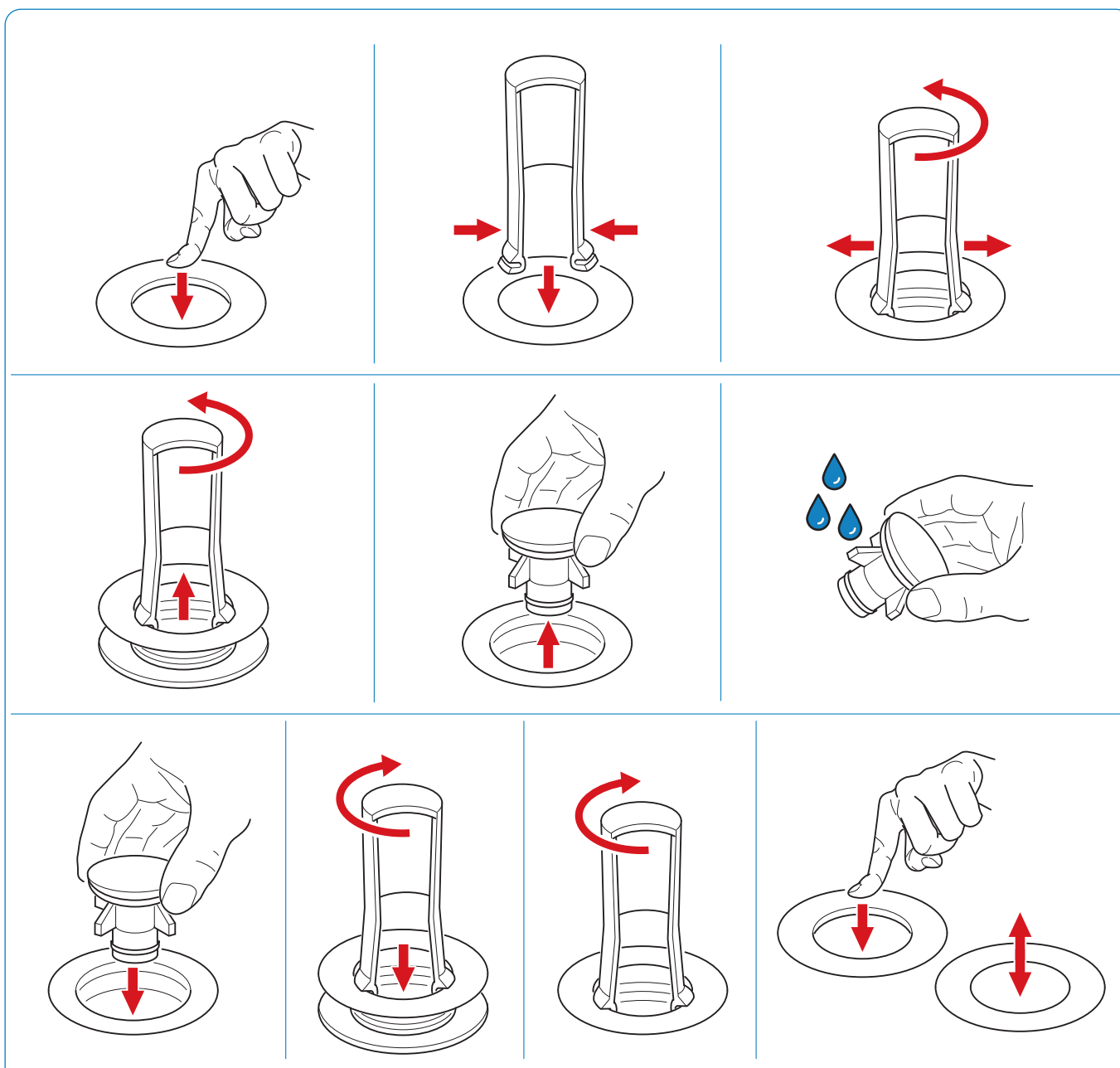

Pulire con un sapone neutro, applicare con un panno umido, strofinare leggermente e quindi scaquare con acqua. Infine lucidare con un panno morbido e asciutto. Per macchie di calcare pulire con una soluzione di acqua (80%) e aceto bianco (20%), per un'azione igienizzante aggiungere alla soluzione del bicarbonato di sodio. Asciugare sempre la superficie in modo da evitare le macchie derivanti dall'acqua.

*Clean with a mild soap, apply with a damp cloth, rub lightly and then rinse with water. Finally polish with a soft and dry cloth. For limescale stains, clean with a solution of water (80%) and white vinegar (20%), add sodium bicarbonate to the solution for a sanitizing action. Always dry the surface to avoid stains resulting from water.*



la resistenza alla corrosione al nichel-cromo si riduce sotto l'azione di acidi e composti alogenati (cloruri, bromuri, ioduri). Non utilizzare mai soluzioni a base di cloro (candeggina), detersivi o spugne abrasive. Evitare la ruggine causata da materiali esterni (es. paglietta di acciaio).



*the corrosion resistance to nickel-chromium is reduced under the action of acids and halogenated compounds (chlorides, bromides, iodides). Never use chlorine-based solutions (bleach), detergents or abrasive sponges. Avoid rust caused by external materials (e.g. steel wool).*

**Contenuto del KIT**  
*Content of the KIT*



Gelcoat (20g)  
Gelcoat (20g)

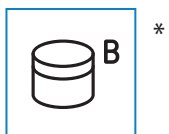

Pasta lucidante (20)  
Polishing paste (20)

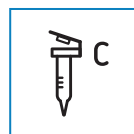

Indurente (0,3g)  
Hardener (0,3g)

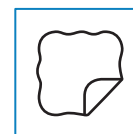

Panno morbido (100x100mm)  
Soft cloth (100x100mm)

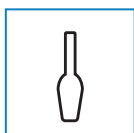

Spatola  
Spatula



Blocchetto lucidante  
Polishing block



Carta smerigliata rossa  
Red emery paper

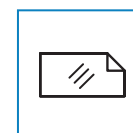

Carta smerigliata grigia  
Grey emery paper

\* Conservare questa confezione - la pasta potrà essere utilizzata nel futuro per correggere piccoli difetti sulle superfici sanitarie.  
Keep the packaging - it can be used for polishing/removal of small scratches on cast marble surface.

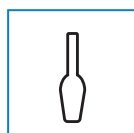

Utensile affilato  
Sharp tool



Guanti  
Gloves



Sgrassante  
Degreaser



**Durante le operazioni di riparazione indossare sempre i guanti di gomma**  
**The repair should be performed in rubber gloves**



**Prima dell'utilizzo del kit, leggere il volantino presente sotto le etichette delle confezioni.**  
**For kit usage, read the note under the label on the packages.**

**Sequenza operazioni**  
*Sequenza operazioni*



**1.** Con l'utensile affilato pulire la parte danneggiata togliendo i residui di Gelcoat, polvere ed altri contaminanti.

**1.** Use the sharp tool to clean the damaged part removing Gelcoat residues, dust and other contaminants.

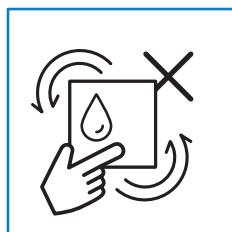

**2.** Pulire la parte danneggiata con lo sgrassante (es. acetone, alcool).

**2.** Clean the damaged part with the degreaser (es. acetone, alcohol).

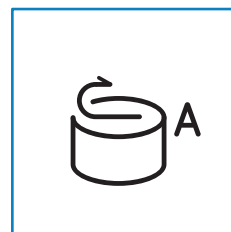

**3.** Aprire la confezione di Gelcoat - per fare ciò togliere con cautela il film protettivo.

**3.** Open the Gelcoat package - remove the protective film with caution.



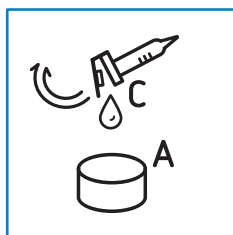

4. Aprire il contenitore con l'indurente.

4. *Open the container with the hardener.*

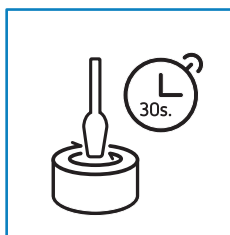

5. Usando la spatola, mescolare energicamente i componenti per 30 secondi.

5. *Using the spatula, energetically mix the components for 30 seconds.*

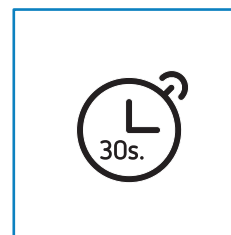

6. Riporre la massa ed attendere altri 30 secondi.  
**Attenzione: la massa diventa dura.**

6. *Leave the mass and wait another 30 seconds.*  
**Warning: the mass hardens.**

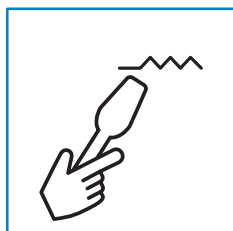

7. Con un'estremità della spatola applicare la massa preparata sulla parte danneggiata.

7. *With one end of the spatula, apply the prepared mass on the damaged part.*

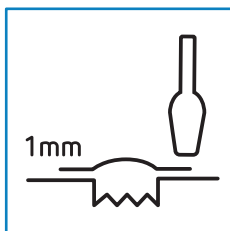

8. Applicare una quantità adeguata della massa fino ad avere una eccedenza di 1mm sopra la superficie.

8. *Apply an appropriate quantity of mass until you obtain an excess of 1mm above the surface.*

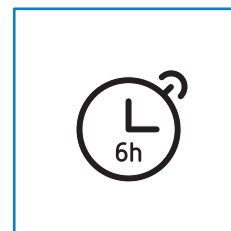

9. Riporre il prodotto così preparato per l'asciugatura.  
**Minimo 56 ore.**

9. *Store the product prepared this way for drying.*  
**Minimum: 56 hours.**

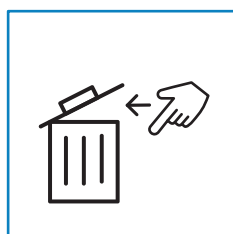

10. Al termine dell'applicazione, chiudere le confezioni usate di Gelcoat e indurente. Gettarle insieme agli attrezzi utilizzati. La confezione con la pasta può essere conservata per un futuro utilizzo.

10. *At the end of application, close the used packages of Gelcoat and hardener. Put them together with the tools you used. The package with the paste can be stored for future use.*



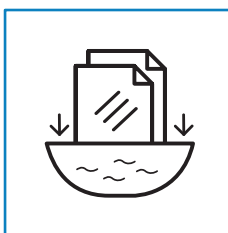

11. Mettere a bagno in acqua entrambi i pezzi di carta smerigliata.

11. Soak both pieces of emery paper in water.

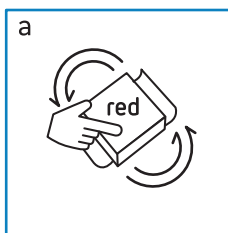

12. Fissare la carta al blocchetto.

Con la parte **rossa**, smerigliare la zona riparata fino a togliere la parte in eccesso della massa ed ottenere una superficie uniforme (a).  
Se la riparazione è stata effettuata su una superficie arrotondata, usare la carta senza il blocchetto (b).

12. Fix paper to the block.

With the **red** part, grind the repaired zone until the part in excess of the mass is removed and an even surface is obtained (a).  
If the repair has been performed on a rounded surface, use the paper without the block (b).

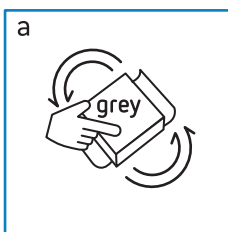
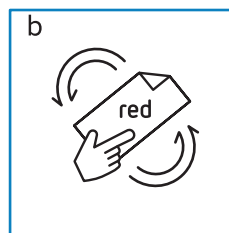

13. Mettere la carta per smerigliare **grigia** sul blocchetto.  
Finire di smerigliare e rendere la parte trattata liscia (a).  
Se la riparazione è stata effettuata su una superficie arrotondata, usare la carta senza il blocchetto (b).

13. Put the **grey** emery paper on the block.  
Finish grinding and make the treated part smooth (a).  
If the repair has been performed on a rounded surface, use the paper without the block (b).

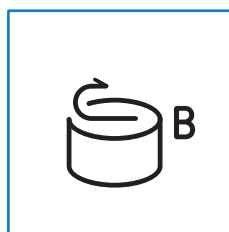
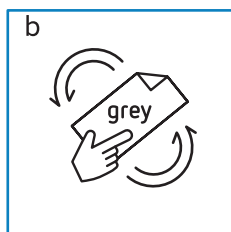

14. Togliere il film protettivo ed aprire la confezione di pasta lucidante.

14. Remove the protective film and open the package of polishing paste.

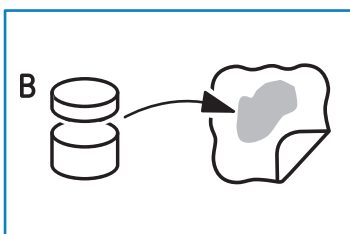

15. Mettere la pasta lucidante sul panno morbido.

15. Apply the polishing paste to the soft cloth.

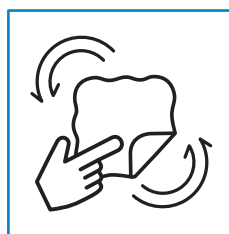

16. Premere con il panno sulla parte da lucidare e con movimenti circolari lucidare la parte riparata.

16. Press the cloth on the part which must be polished and polish the repaired part with circular motions.