

# NEW HOLIDAY

Cabina doccia Multifunzione.

## TUTTE LE FUNZIONI E DOTAZIONI DISPONIBILI



Idromassaggio verticale (5 jets orientabili)

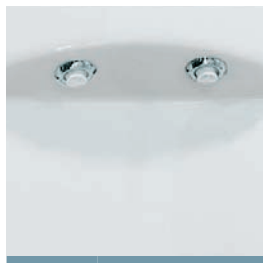

Idromassaggio cervicale (2 jets orientabili)

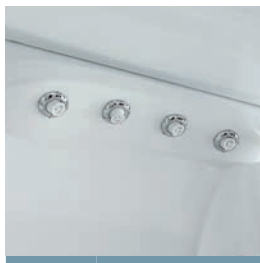

Rotopioggia (4 jets orientabili) escluso mod. R115



Soffione doccia ø 200 mm



Cascata solo mod. R115

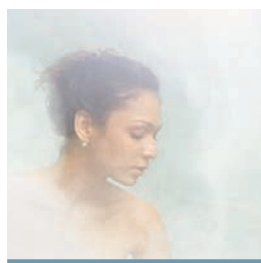

Sauna di vapore



Erogatore di vapore con dispenser di aromi



Telecomando Touch Screen Sauna regolabile, radio, orologio, allarme

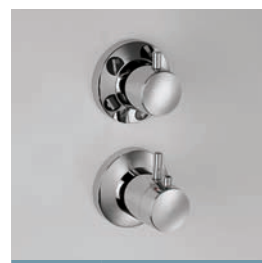

Miscelatore meccanico o termostatico

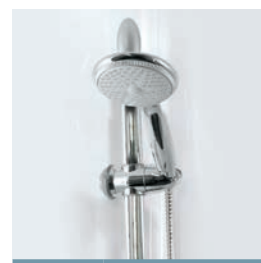

Doccia a mano

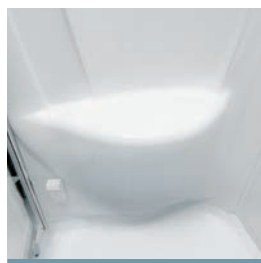

Sedile

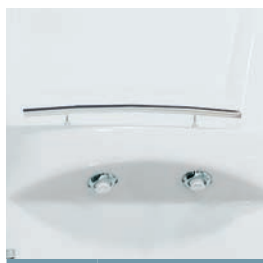

2 Ripiani portaoggetti

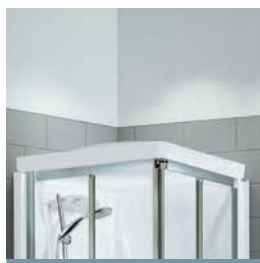

Tettuccio

## FINITURE PROFILI

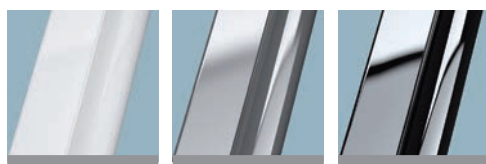

Bianco

Silver

Cromo

## VETRI TEMPRATI

(European standards UNI EN 14428)

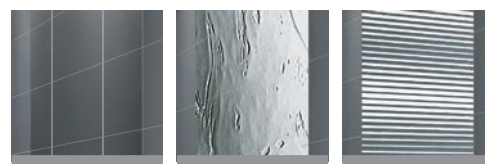

Trasparente spessore 4 mm

Aqua spessore 4 mm

Serigrafia Esprit spessore 4 mm

## TRATTAMENTI



### TRATTAMENTO ANTIGOCCIA

Cristalli sempre brillanti, facili da pulire. Impedisce la formazione del calcare e dei batteri. **Solo su vetri trasparenti.**



### FINITURA CROMO

Ciclo di produzione integrata a zero emissioni, 100% ecologico. Anticalcare, resistente all'azione batterica, ecologica brillantezza resistente nel tempo.

# NEW HOLIDAY R90



200 cm



4 mm



p. 487

## CABINA DOCCIA MULTIFUNZIONE

### BOX SEMICIRCOLARE: APERTURA 2 ANTE SCORREVOLI E 2 FISSE

Miscelatore	Dimensioni cm	Altezza totale cm	Apertura cm	Codice	Scelta vetro			Scelta Profilo / Prezzo		
					1	2	5	D	B	K
					Trasparente	Aqua	Serigrafia Esprit	Bianco	Silver	Cromo

C

\*

## STANDARD senza tettuccio



MECCANICO	90 x 90	206	48	NNH R 90 M-	●					
TERMOSTATICO	90 x 90	206	48	NNH R 90 T-	●					

## STANDARD con tettuccio



MECCANICO	90 x 90	217	48	NNH R 90 M T-	●					
TERMOSTATICO	90 x 90	217	48	NNH R 90 T T-	●					

## IDROMASSAGGIO senza tettuccio



MECCANICO	90 x 90	206	48	NNH R 90 M 19-	●					
TERMOSTATICO	90 x 90	206	48	NNH R 90 T 19-	●					

## IDROMASSAGGIO con tettuccio



MECCANICO	90 x 90	217	48	NNH R 90 M 19 F-	●					
TERMOSTATICO	90 x 90	217	48	NNH R 90 T 19 F-	●					

## HAMMAM



MECCANICO	90 x 90	225,5	48	NNH R 90 M 19 N-	●					
TERMOSTATICO	90 x 90	225,5	48	NNH R 90 T 19 N-	●					

ESEMPIO COMPILAZIONE CODICE:

NNR90M-1D

=

NNR90M-

+

1

+

D

● Disponibilità indicativa deposito centrale 7gg.



NEW HOLIDAY

NELLA FOTO: INSTALLAZIONE AD ANGOLO - HAMMAM CON TETTuccio

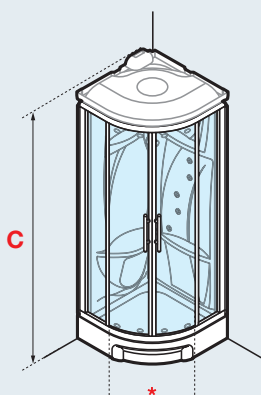

**OPTIONAL**



Pedana in EVA,  
impermeabile all'acqua,  
antibatterica e atossica  
90 x 90 cm  
**PEDNTR90**

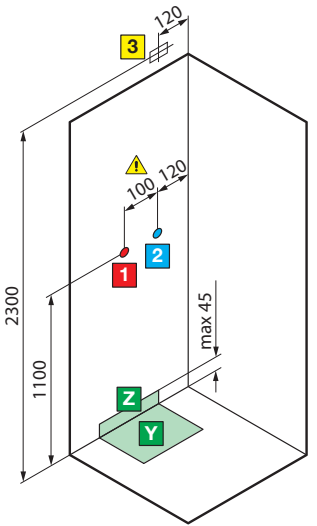
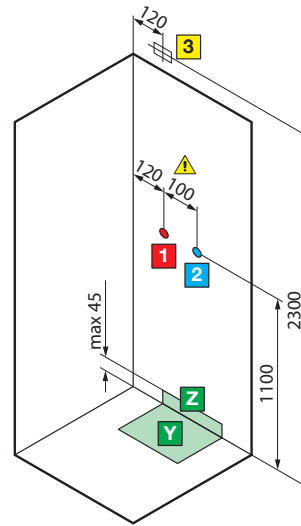
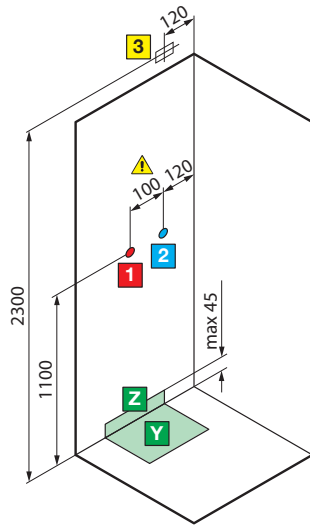
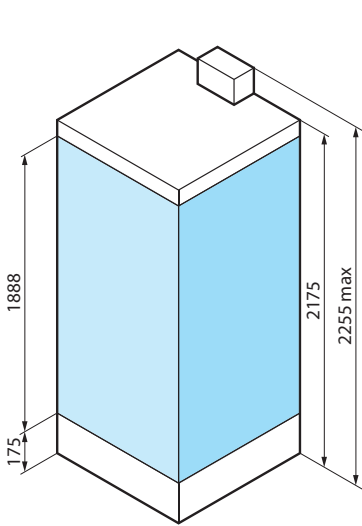

per i modelli  
**A90 - GF90**  
**BI90 - BI100 - BI120 - S2F100**

versione **sinistra**      versione **destra**  
 per modelli **A80 - GF80 - 2P100x70 - 2P120x80 - SF100x80**

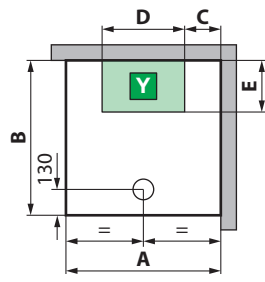
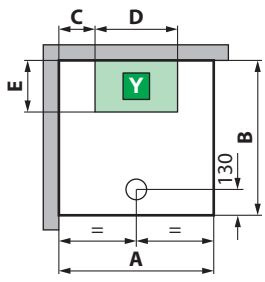

Solo per modelli  
**BI90, BI100 - BI120, S2F100**

modello	A ± 5	B ± 5	C	D	E
<b>A80</b>	804	804	200	404	300
<b>A90</b>	904	904	200	504	300
<b>GF80</b>	804	804	200	404	300
<b>GF90</b>	904	904	200	504	300

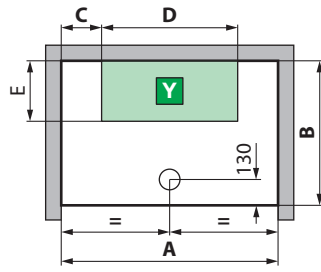
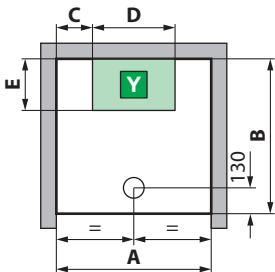

modello	A ± 5	B ± 5	C	D	E
<b>BI90</b>	904	904	200	504	300
<b>BI100</b>	1004	804	200	604	300
<b>BI120</b>	1204	804	200	804	300
<b>S2F100</b>	1004	804	200	604	300

**S** INSTALLAZIONE A SINISTRA

**D** INSTALLAZIONE A DESTRA

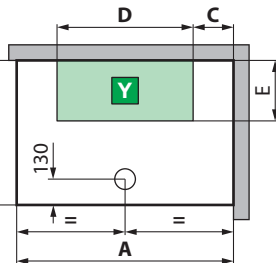
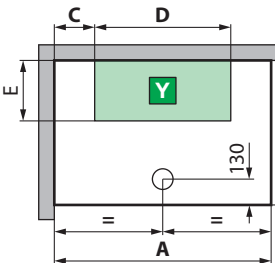

modello	A ± 5	B ± 5	C	D	E
<b>2P100x70</b>	1004	704	200	604	300
<b>2P120x80</b>	1204	804	200	804	300
<b>SF100x80</b>	1004	804	200	604	300

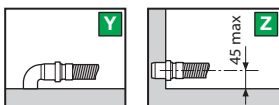
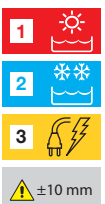

**ATTENZIONE!**  
 Può essere dannoso ai portatori di pacemakers

**CARATTERISTICHE IDRAULICHE:**  
 Pressione dinamica ottimale 2÷5 bar  
 Acqua calda 1/2"  
 Acqua fredda 1/2"  
 Allaccio sifone con raccordo ø 40 mm

**CARATTERISTICHE ELETTRICHE:**  
 Tensione 220 - 230 V  
 Frequenza 50/60 Hz  
 Potenza massima assorbita: 2600 W  
 Potenza nominale: 2500 W

**ATTENZIONE!** Installare a monte dell'apparecchio un interruttore differenziale da 30mA provvisto di interruttore onnipolare con apertura minima dei contatti ≥ 3 mm.

## MOD. R90

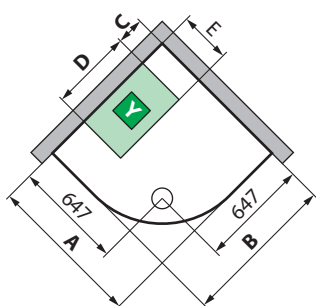
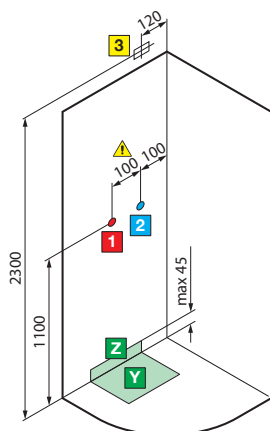
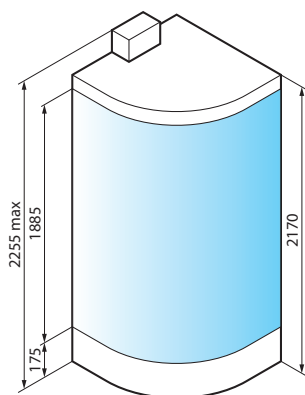

mod.	A ± 5	B ± 5	C	D	E
<b>R90</b>	904	904	200	504	300

## MOD. R115

### S INSTALLAZIONE A SINISTRA

### D INSTALLAZIONE A DESTRA

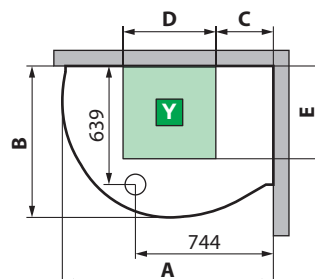
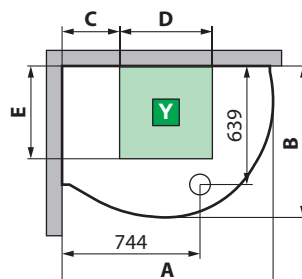
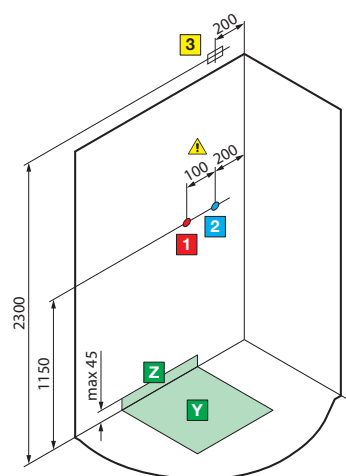
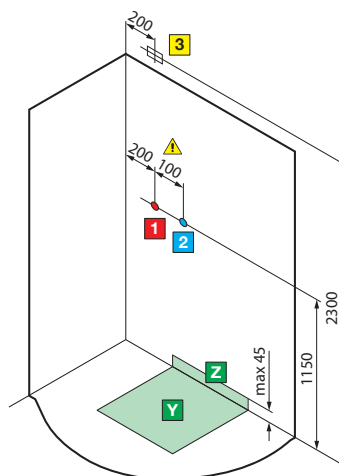
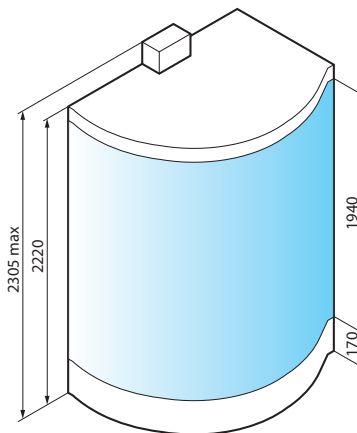
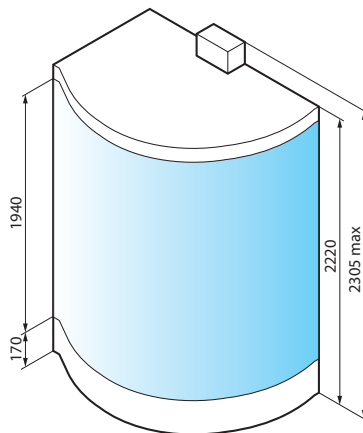

mod.	A ± 5	B ± 5	C	D	E
<b>R115</b>	1138	817	310	500	500

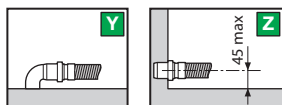
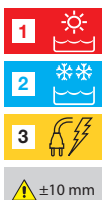

**CARATTERISTICHE IDRAULICHE:**  
 Pressione dinamica ottimale 2÷5 bar  
 Acqua calda 1/2"  
 Acqua fredda 1/2"  
 Allaccio sifone con raccordo ø 40 mm

**CARATTERISTICHE ELETTRICHE:**  
 Tensione 220 - 230 V  
 Frequenza 50/60 Hz  
 Potenza massima assorbita: 2600 W  
 Potenza nominale: 2500 W

**ATTENZIONE!** Installare a monte dell'apparecchio un interruttore differenziale da 30mA provvisto di interruttore onnipolare con apertura minima dei contatti ≥ 3 mm.