

NEW HOLIDAY

Cabina doccia Multifunzione.

TUTTE LE FUNZIONI E DOTAZIONI DISPONIBILI



Idromassaggio verticale (5 jets orientabili)

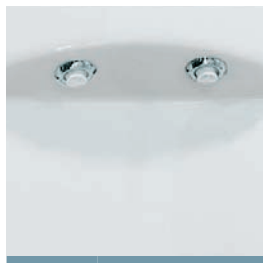

Idromassaggio cervicale (2 jets orientabili)

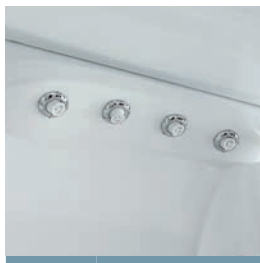

Rotopioggia (4 jets orientabili) escluso mod. R115



Soffione doccia ø 200 mm



Cascata solo mod. R115

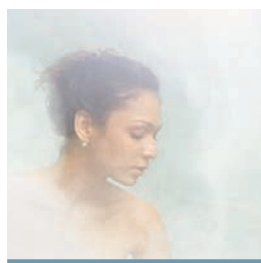

Sauna di vapore



Erogatore di vapore con dispenser di aromi



Telecomando Touch Screen Sauna regolabile, radio, orologio, allarme

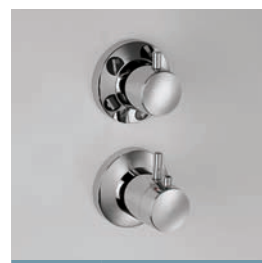

Miscelatore meccanico o termostatico

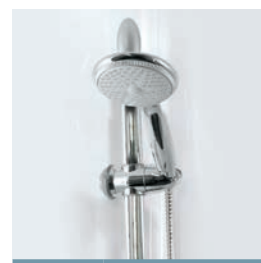

Doccia a mano

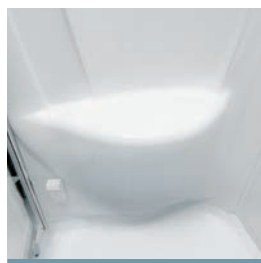

Sedile

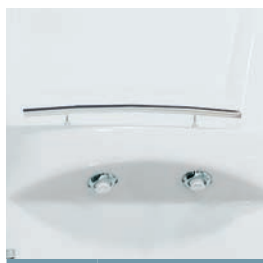

2 Ripiani portaoggetti

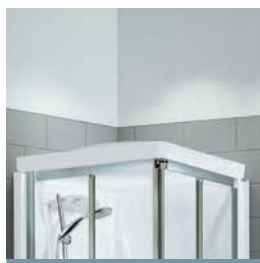

Tettuccio

FINITURE PROFILI

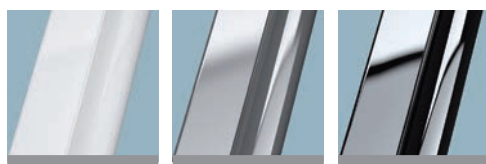

Bianco

Silver

Cromo

VETRI TEMPRATI

(European standards UNI EN 14428)

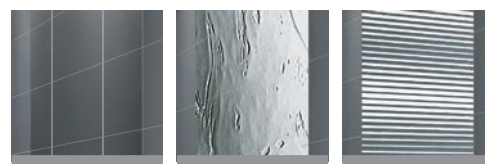

Trasparente spessore 4 mm

Aqua spessore 4 mm

Serigrafia Esprit spessore 4 mm

TRATTAMENTI



TRATTAMENTO ANTIGOCCIA

Cristalli sempre brillanti, facili da pulire. Impedisce la formazione del calcare e dei batteri. **Solo su vetri trasparenti.**



FINITURA CROMO

Ciclo di produzione integrata a zero emissioni, 100% ecologico. Anticalcare, resistente all'azione batterica, ecologica brillantezza resistente nel tempo.

NEW HOLIDAY 2P120x80



200 cm



4 mm



p. 486

CABINA DOCCIA MULTIFUNZIONE

BOX ASIMMETRICO: APERTURA 1 ANTA SCORREVOLE E 1 FISSA IN LINEA CON FISSO LATERALE

Miscelatore	Dimensioni cm	Altezza totale cm	Apertura cm	Codice	Scelta vetro			Scelta Profilo / Prezzo		
					1	2	5	D	B	K
					Trasparente	Aqua	Serigrafia Esprit	Bianco	Silver	Cromo

C

*

STANDARD senza tettuccio



MECCANICO	120 x 80	206	47	NNH2P 120 M-						
TERMOSTATICO	120 x 80	206	47	NNH2P 120 T-						

STANDARD con tettuccio



MECCANICO	120 x 80	217	47	NNH2P 120 M T-						
TERMOSTATICO	120 x 80	217	47	NNH2P 120 T T-						

IDROMASSAGGIO senza tettuccio



MECCANICO	120 x 80	206	47	NNH2P 120 M 19-						
TERMOSTATICO	120 x 80	206	47	NNH2P 120 T 19-						

IDROMASSAGGIO con tettuccio



MECCANICO	120 x 80	217	47	NNH2P 120 M 19 F-						
TERMOSTATICO	120 x 80	217	47	NNH2P 120 T 19 F-						

HAMMAM



MECCANICO	120 x 80	225,5	47	NNH2P 120 M 19 N-						
TERMOSTATICO	120 x 80	225,5	47	NNH2P 120 T 19 N-						

ESEMPIO COMPILAZIONE CODICE:

NNH2P120M-1D

=

NNH2P120M-

+

1

+

D

● Disponibilità indicativa deposito centrale 7gg.



NEW HOLIDAY

NELLA FOTO: INSTALLAZIONE DESTRA - HAMMAM CON TETTuccio

INSTALLAZIONE A SINISTRA

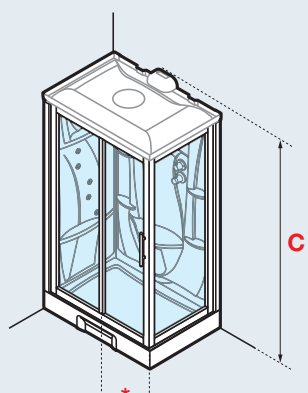

INSTALLAZIONE A DESTRA

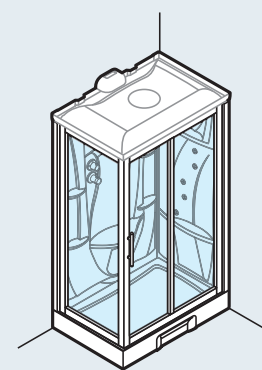

Le pareti di fondo si possono invertire per installazioni a destra o sinistra

OPTIONAL



Pedana in EVA, impermeabile all'acqua, antibatterica e atossica
120x80 cm
PEDNT120

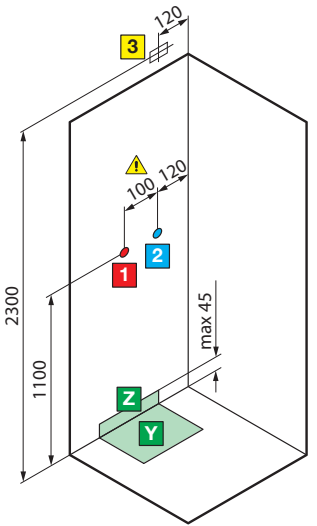
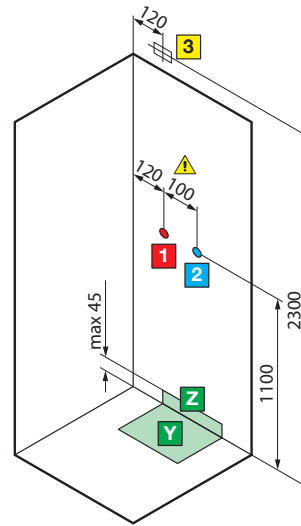
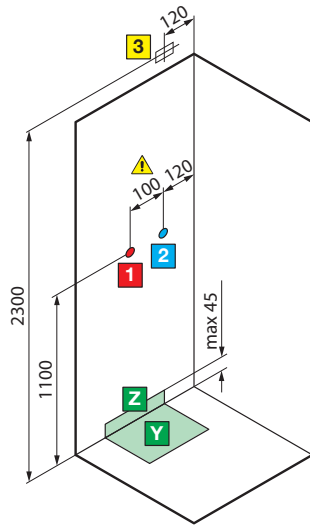
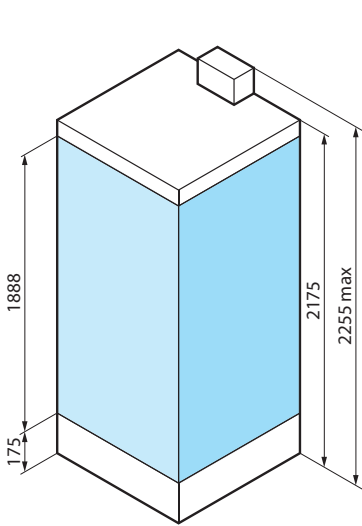

per i modelli
A90 - GF90
BI90 - BI100 - BI120 - S2F100

versione **sinistra** versione **destra**
per modelli **A80 - GF80 - 2P100x70 - 2P120x80 - SF100x80**

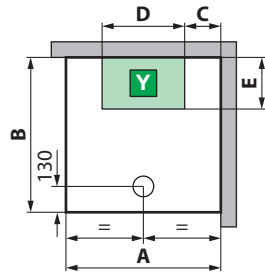
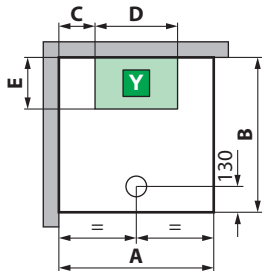

Solo per modelli
BI90, BI100 - BI120, S2F100

modello	A ± 5	B ± 5	C	D	E
A80	804	804	200	404	300
A90	904	904	200	504	300
GF80	804	804	200	404	300
GF90	904	904	200	504	300

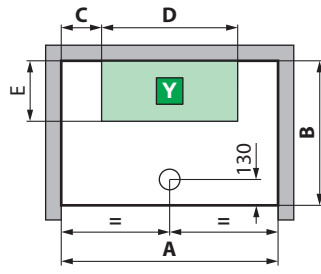
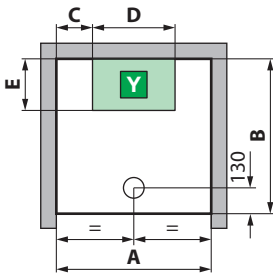

modello	A ± 5	B ± 5	C	D	E
BI90	904	904	200	504	300
BI100	1004	804	200	604	300
BI120	1204	804	200	804	300
S2F100	1004	804	200	604	300

S INSTALLAZIONE A SINISTRA

D INSTALLAZIONE A DESTRA

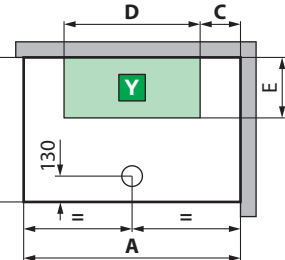
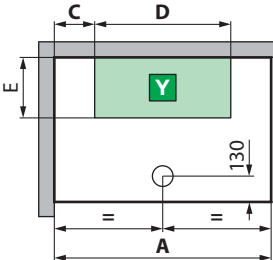

modello	A ± 5	B ± 5	C	D	E
2P100x70	1004	704	200	604	300
2P120x80	1204	804	200	804	300
SF100x80	1004	804	200	604	300

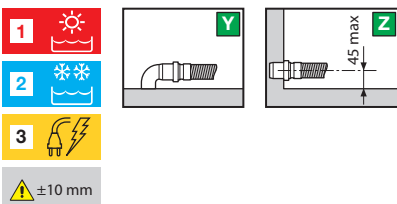

ATTENZIONE!
Può essere dannoso ai portatori di pacemakers

CARATTERISTICHE IDRAULICHE:
Pressione dinamica ottimale 2÷5 bar
Acqua calda 1/2"
Acqua fredda 1/2"
Allaccio sifone con raccordo ø 40 mm

CARATTERISTICHE ELETTRICHE:
Tensione 220 - 230 V
Frequenza 50/60 Hz
Potenza massima assorbita: 2600 W
Potenza nominale: 2500 W

ATTENZIONE! Installare a monte dell'apparecchio un interruttore differenziale da 30mA provvisto di interruttore onnipolare con apertura minima dei contatti ≥ 3 mm.

MOD. R90

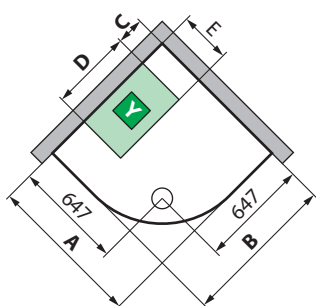
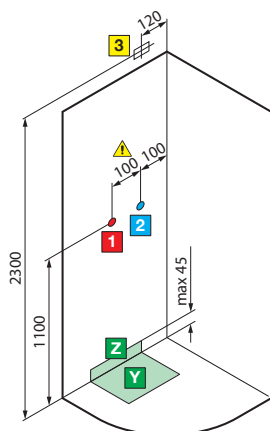
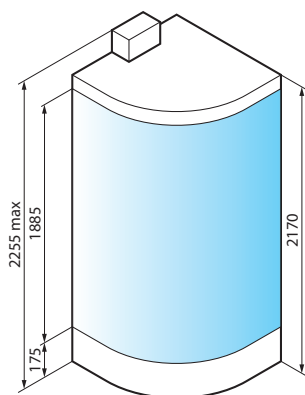

mod.	A ± 5	B ± 5	C	D	E
R90	904	904	200	504	300

MOD. R115

S INSTALLAZIONE A SINISTRA

D INSTALLAZIONE A DESTRA

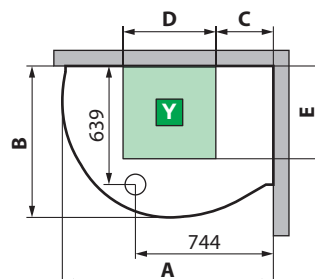
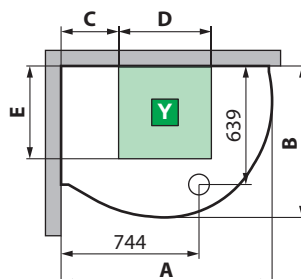
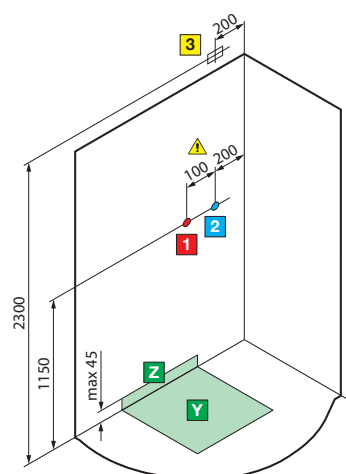
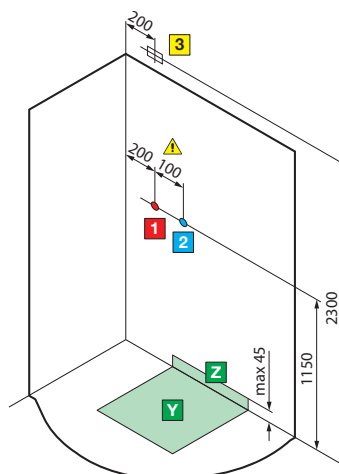
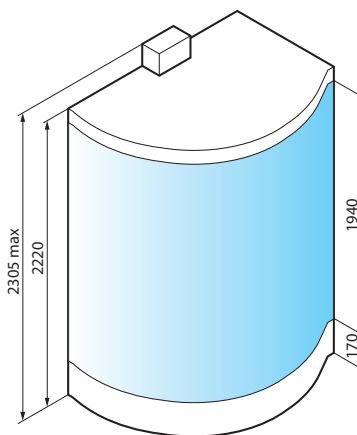
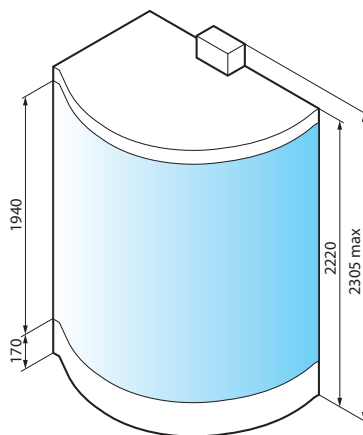

mod.	A ± 5	B ± 5	C	D	E
R115	1138	817	310	500	500

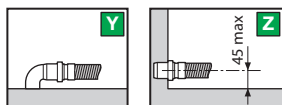
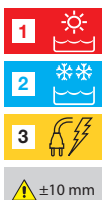

CARATTERISTICHE IDRAULICHE:
 Pressione dinamica ottimale 2÷5 bar
 Acqua calda 1/2"
 Acqua fredda 1/2"
 Allaccio sifone con raccordo ø 40 mm

CARATTERISTICHE ELETTRICHE:
 Tensione 220 - 230 V
 Frequenza 50/60 Hz
 Potenza massima assorbita: 2600 W
 Potenza nominale: 2500 W

ATTENZIONE! Installare a monte dell'apparecchio un interruttore differenziale da 30mA provvisto di interruttore onnipolare con apertura minima dei contatti ≥ 3 mm.