

# GLAX 2 2.0 A+F



CABINA MULTIFUNZIONE, APERTURA 2 ANTE SCORREVOLI E 2 FISSE + FISSO LATERALE

Design Marco Pellici



## OPTIONAL



SEDILE IN ACRILICO OPALINO

Codice Prezzo

SED030PL

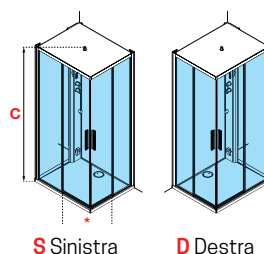

Misure				Codice	Installazione		Miscelatore		Vetro	Scelta finitura		
Dimensioni (cm)	Piatto doccia (cm)	Altezza totale (cm)	Entrata (cm)		D	S	M	T		UU	HH	BB
		<b>C</b>	<b>*</b>		Destra	Sinistra	Meccanico	Termostatico	Trasparente	Bianco	Nero	Silver
<b>STANDARD</b>												
					<b>D</b>	<b>S</b>	<b>M-</b>	<b>T-</b>	<b>1</b>	<b>UU</b>	<b>HH</b>	<b>BB</b>
100 X 80	4,5	210	47,5	<b>G21AF108</b>								
100 X 80	11,5	217	47,5	<b>G21AF198</b>								
<b>STANDARD + TETTUCCIO</b>												
					<b>D</b>	<b>S</b>	<b>MF-</b>	<b>TF-</b>	<b>1</b>	<b>UU</b>	<b>HH</b>	<b>BB</b>
100 X 80	4,5	217	47,5	<b>G21AF108</b>								
100 X 80	11,5	224	47,5	<b>G21AF198</b>								
<b>STANDARD+TETTUCCIO+LIGHT</b>												
					<b>D</b>	<b>S</b>	<b>MFL-</b>	<b>TFL-</b>	<b>1</b>	<b>UU</b>	<b>HH</b>	<b>BB</b>
100 X 80	4,5	217	47,5	<b>G21AF108</b>								
100 X 80	11,5	224	47,5	<b>G21AF198</b>								
<b>HAMMAM</b>												
					<b>D</b>	<b>S</b>	<b>M5-</b>	<b>T5-</b>	<b>1</b>	<b>UU</b>	<b>HH</b>	<b>BB</b>
100 X 80	4,5	217	47,5	<b>G21AF108</b>								
100 X 80	11,5	224	47,5	<b>G21AF198</b>								



WHITE



BLACK



SILVER









## GLAX 1 2.0 | FINITURE

	PROFILI	MANIGLIA	COLONNA	PORTASAPONE	PARETI DI FONDO	PIATTO	TETTUCCIO *	SEDILE *
<b>WHITE</b>	Bianco opaco	Bianco opaco	Bianco opaco	Bianco opaco	Bianco	Bianco lucido	Bianco opaco	Bianco
<b>BLACK</b>	Nero opaco	Nero opaco	Nero opaco	Nero opaco	Bianco	Bianco lucido	Bianco opaco	Bianco
<b>SILVER</b>	Silver	Cromo	Silver	Cromo	Bianco	Bianco lucido	Bianco opaco	Bianco

\* disponibili a seconda dell' allestimento

## GLAX 1 2.0 | FUNZIONI E DOTAZIONI (disponibili a seconda dell'allestimento)



-   Miscelatore meccanico o termostatico e doccia a mano con flessibile orientabile
-   Tettuccio con soffione doccia
-  Ripiani d'appoggio
-  Bluetooth
-  Sedile reclinabile
-  Pannello di controllo elettronico soft-touch
-   Cromolight (versione sauna basic)  
Luce led (versione standard+tettuccio+light)
-  HAMMAM (Sauna di vapore + erogatore di vapore con dispenser di aromi)

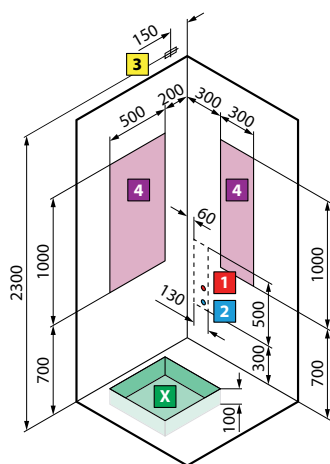
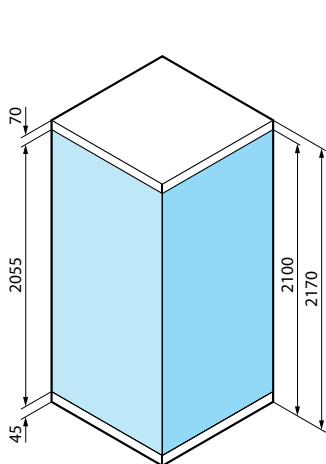

per modelli  
**A80 - A90 - A100 - GF80 - GF90 - R90 - R100**

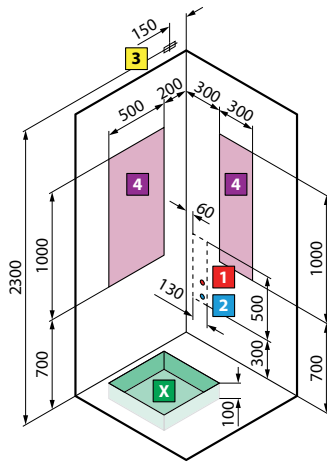

versione **destra**

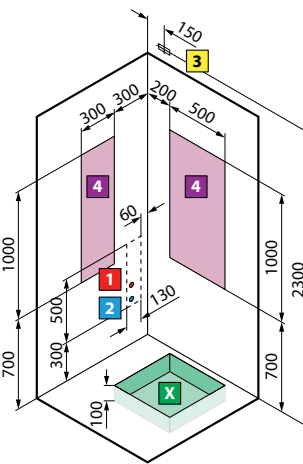

versione **sinistra**  
per mod. **A90x70 - A100x70 - A100x80 - 2P 120x80 - 2P 120x90**

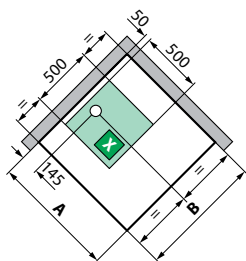

modello	A ± 3	B ± 3
<b>A80</b>	796	796
<b>A90</b>	896	896
<b>A 100</b>	996	996
<b>GF80</b>	796	796
<b>GF90</b>	896	896

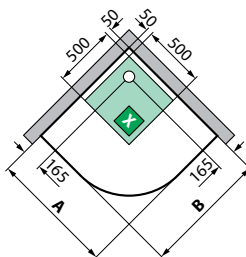

modello	A ± 3	B ± 3
<b>R90</b>	896	896
<b>R100</b>	996	996

### S INSTALLAZIONE A SINISTRA

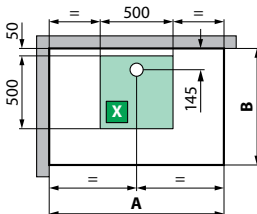

### D INSTALLAZIONE A DESTRA

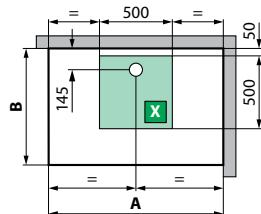

modello	A ± 3	B ± 3
<b>A90x70</b>	896	696
<b>A100x70</b>	996	696
<b>A100x80</b>	996	796
<b>2P120x80</b>	1196	796
<b>2P120x90</b>	1196	896

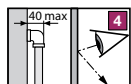
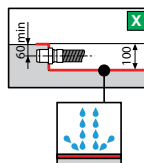
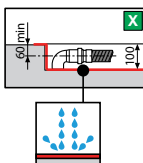

Non ispezionabile

**ATTENZIONE!**  
Può essere dannoso ai portatori di pacemakers

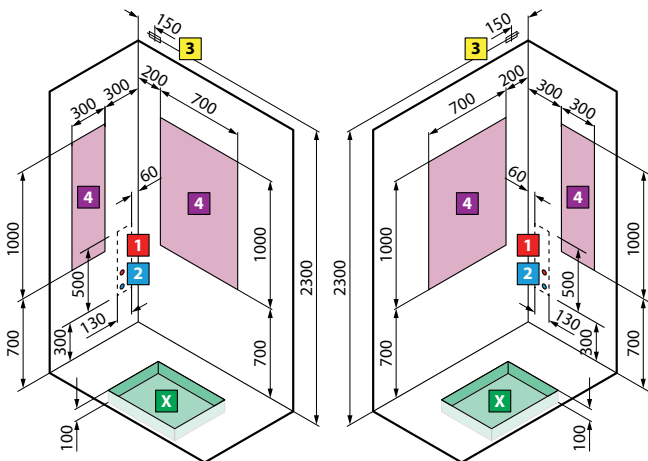

versione **sinistra**

versione **destra**

per mod. **2P140x80 - 2P140x90**

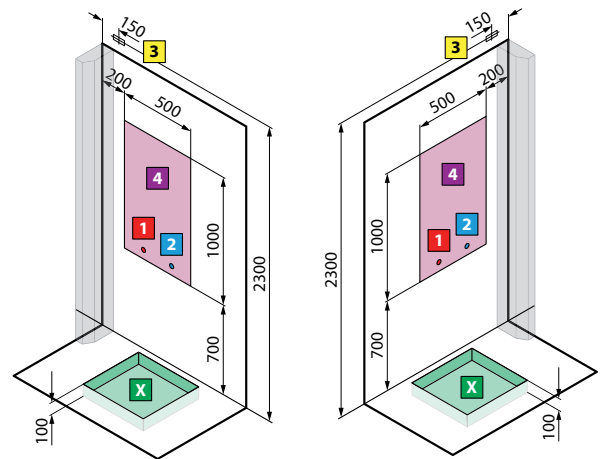

versione **sinistra**

versione **destra**

per mod. **A100x80**

per mod. **A100x80 - 2P120x80**

### S INSTALLAZIONE A SINISTRA

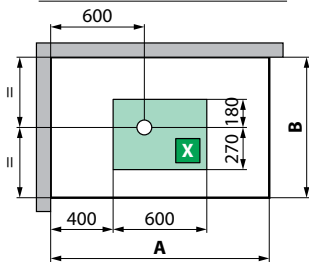

### D INSTALLAZIONE A DESTRA

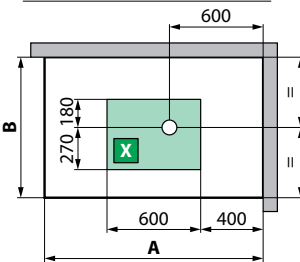

modello	A ± 3	B ± 3
<b>2P140x80</b>	1394	794
<b>2P140x90</b>	1394	894

### S INSTALLAZIONE A SINISTRA

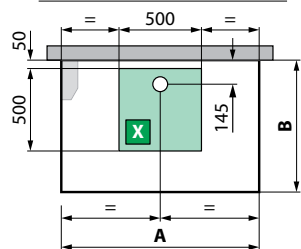

### D INSTALLAZIONE A DESTRA

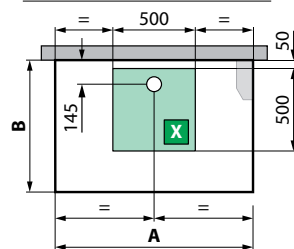

modello	A ± 3	B ± 3
<b>A+F100x80</b>	996	796
<b>2P+2F120x80</b>	1196	796

### CARATTERISTICHE IDRAULICHE:

Pressione dinamica ottimale 2÷5 bar  
 Acqua calda 1/2"  
 Acqua fredda 1/2"  
 Allaccio sifone con raccordo ø 40 mm

### CARATTERISTICHE ELETTRICHE:

Tensione 220 - 230 V  
 Frequenza 50/60 Hz  
 Potenza massima assorbita: 2600 W  
 Potenza nominale: 2500 W

**ATTENZIONE!** Installare a monte dell'apparecchio un interruttore differenziale da 30mA provvisto di interruttore onnipolare con apertura minima dei contatti ≥ 3 mm.

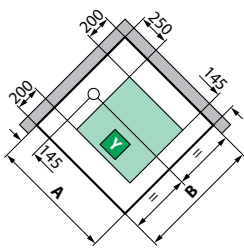
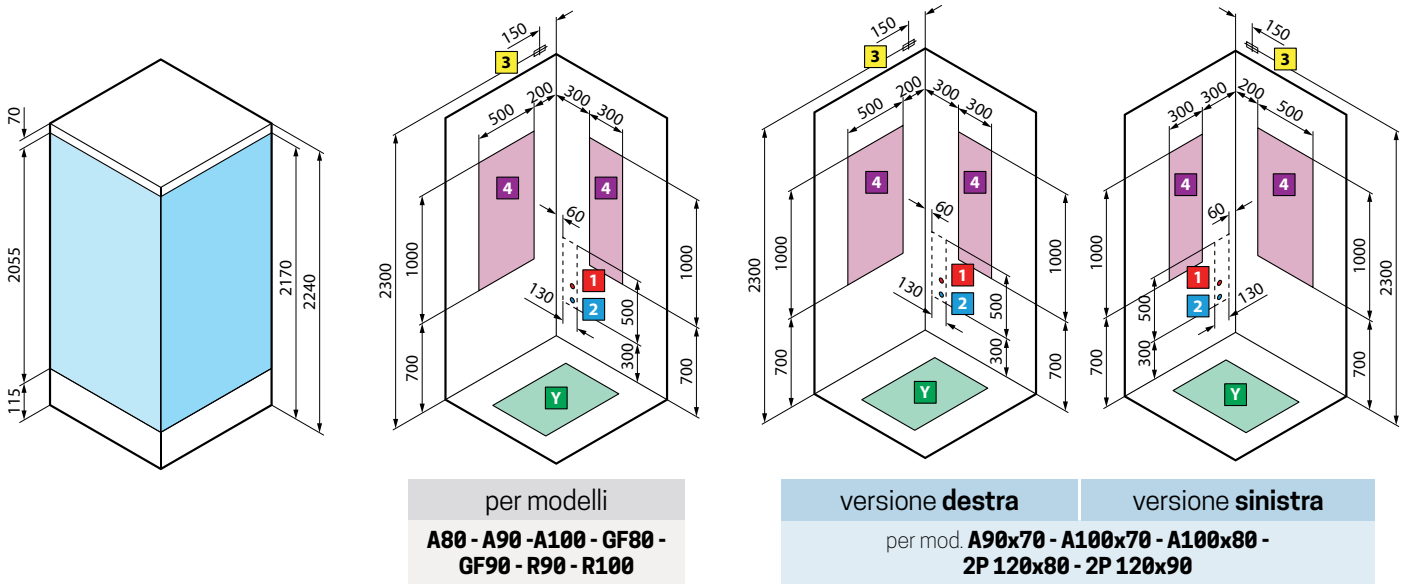

modello	A ± 4	B ± 4
<b>A80</b>	798	798
<b>A90</b>	898	898
<b>A 100</b>	998	998
<b>GF80</b>	798	798
<b>GF90</b>	898	898

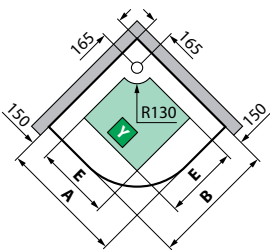

modello	A ± 4	B ± 4	E
<b>R90</b>	898	898	500
<b>R100</b>	998	998	600

## S INSTALLAZIONE A SINISTRA

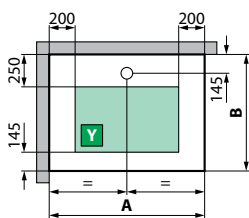

## D INSTALLAZIONE A DESTRA

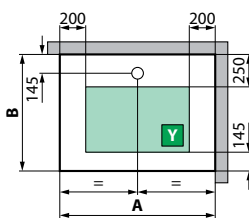

modello	A ± 4	B ± 4
<b>A90x70</b>	898	698
<b>A100x70</b>	998	698
<b>A100x80</b>	998	798
<b>2P120x80</b>	1198	798
<b>2P120x90</b>	1198	898

1

2

3

±10 mm

**ATTENZIONE!**  
Può essere dannoso ai portatori di pacemakers

Non ispezionabile

# GLAX 2.0 PIATTO 125

# DISEGNI TECNICI

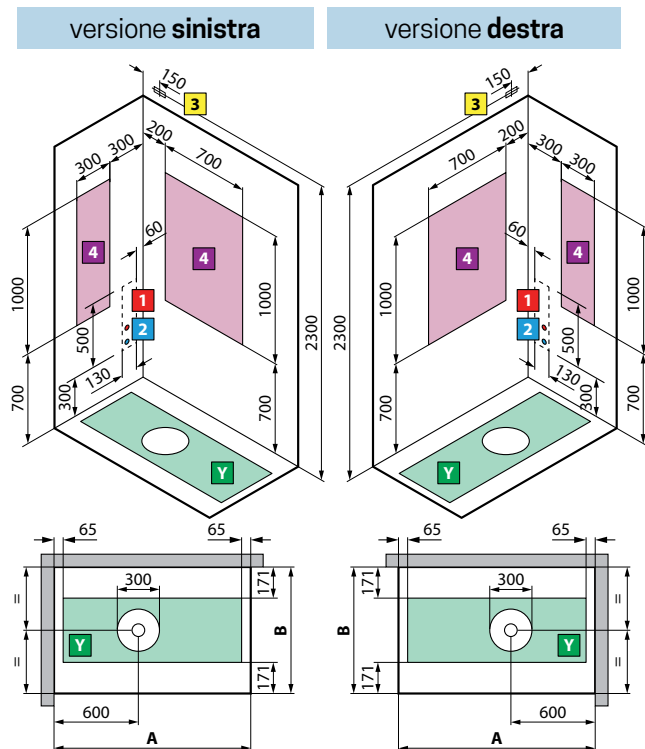
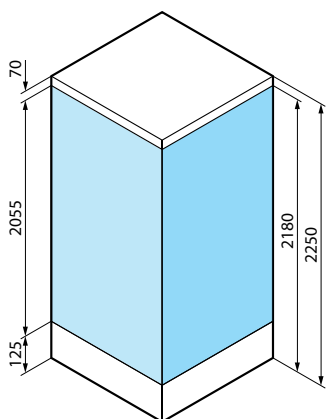

modello	A ± 3	B ± 3
<b>2P140x80</b>	1398	798
<b>2P140x90</b>	1398	898

# GLAX 2.0 PIATTO 115

# DISEGNI TECNICI

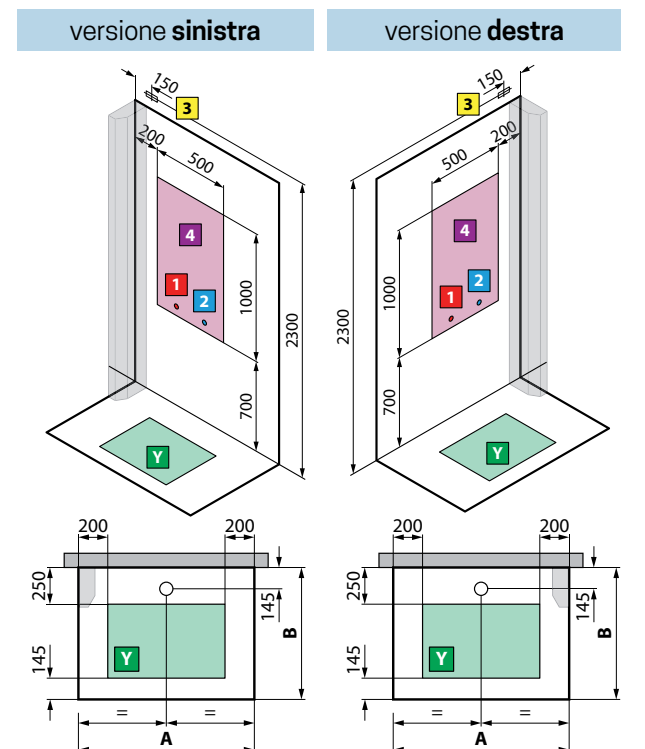
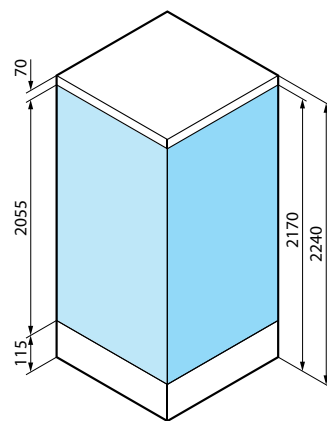

modello	A ± 4	B ± 4
<b>A+F100x80</b>	998	798
<b>2P+2F120x80</b>	1198	798

**CARATTERISTICHE IDRAULICHE:**  
 Pressione dinamica ottimale 2÷5 bar  
 Acqua calda 1/2"  
 Acqua fredda 1/2"  
 Allaccio sifone con raccordo ø 40 mm

**CARATTERISTICHE ELETTRICHE:**  
 Tensione 220 - 230 V  
 Frequenza 50/60 Hz  
 Potenza massima assorbita: 2600 W  
 Potenza nominale: 2500 W

**ATTENZIONE!** Installare a monte dell'apparecchio un interruttore differenziale da 30mA provvisto di interruttore onnipolare con apertura minima dei contatti ≥ 3 mm.