

Moderno e funzionale dalle linee rigorose ed essenziali:  
la qualità senza compromessi



1



2

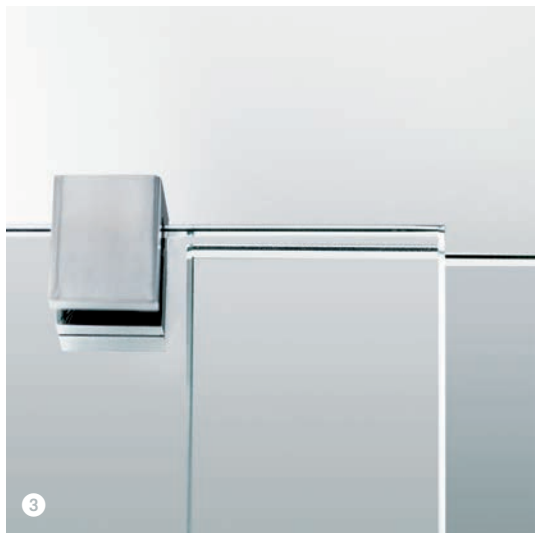

3



4

- 1 Cerniera vista interna con regolazione. 2 Cerniera vista esterna.  
3 Vetri sempre paralleli. 4 Maniglia e cerniere design Marco Pellici.

## TRATTAMENTI



**TRATTAMENTO ANTIGOCCIA**  
Cristalli sempre brillanti, facili da pulire.  
Impedisce la formazione del calcare e  
dei batteri.  
**Solo su vetri trasparenti.**



**FINITURA CROMO PVD**  
Ciclo di produzione integrata a zero emissioni, 100%  
ecologico. Anticalcare, resistente all'azione batterica,  
ecologica brillantezza resistente nel tempo.



# GALA 1B

COLLEZIONE *elysium*



PORTA DOCCIA, APERTURA 1 ANTA BATTENTE E 1 FISSO IN LINEA, IN NICCHIA

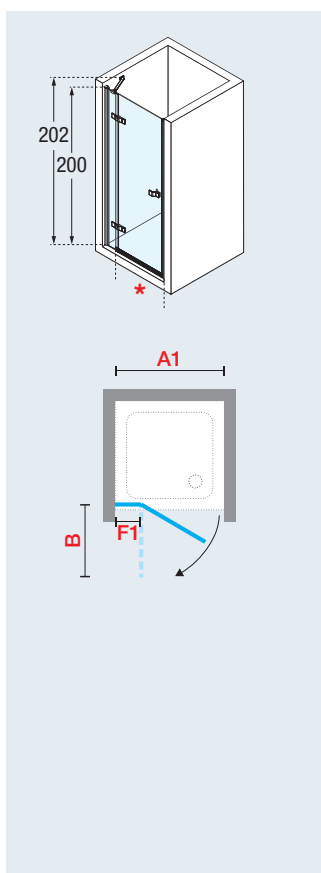

Misure						Codice	Sinistra	Destra	Vetro	Profilo/Prezzo
Misura effettiva d'ingombro	Fisso frontale	Entrata		Ingombro anta esterno			S-	D-	1	K
		min	max	min	max					
<b>A</b>	<b>F</b>	<b>*</b>	<b>B</b>						Trasparente	Cromo

## VERSIONE CON PROFILO A MURO

77 ↔ 79,5	18	51	53	54	57	<b>GALA1 1B 80</b>				
87 ↔ 89,5	18	61	63	64	67	<b>GALA1 1B 90</b>				
97 ↔ 99,5	18	71	73	74	77	<b>GALA1 1B 100</b>				
107 ↔ 109,5	18	81	83	84	87	<b>GALA1 1B 110</b>				
117 ↔ 119,5	28	81	83	84	87	<b>GALA1 1B 120</b>				
<b>H 150 ↓ 210</b>		<b>L 77 ↔ 120</b>		SPECIAL		<b>GALA1 1B SP</b>				

## VERSIONE CON STAFFE

77 ↔ 79,5	18	51	53	54	57	<b>GALA2 1B 80</b>				
87 ↔ 89,5	18	61	63	64	67	<b>GALA2 1B 90</b>				
97 ↔ 99,5	18	71	73	74	77	<b>GALA2 1B 100</b>				
107 ↔ 109,5	18	81	83	84	87	<b>GALA2 1B 110</b>				
117 ↔ 119,5	28	81	83	84	87	<b>GALA2 1B 120</b>				
<b>H 150 ↓ 210</b>		<b>L 77 ↔ 120</b>		SPECIAL		<b>GALA2 1B SP</b>				

ESEMPIO COMPILAZIONE CODICE:

GALA11B80S-1K = GALA11B80 + S- + 1 + K

# BARRE DI SOSTEGNO

## BARRA DI SOSTEGNO STANDARD (IN DOTAZIONE)



### OPTIONAL

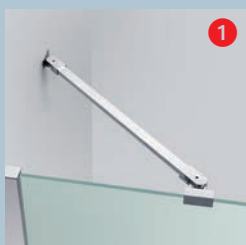

1

#### Barra di sostegno orientabile

- 1 barra orientabile da 100/150/180 cm (accorciabile)

Finitura	cm	Codice	Prezzo
Bianco	100	<b>R80KUOR100-D</b>	
Silver		<b>R80KUOR100-B</b>	
Cromo		<b>R80KUOR100-K</b>	
Bianco	150	<b>R80KUOR150-D</b>	
Silver		<b>R80KUOR150-B</b>	
Cromo		<b>R80KUOR150-K</b>	
Bianco	180	<b>R80KUOR180-D</b>	
Silver		<b>R80KUOR180-B</b>	
Cromo		<b>R80KUOR180-K</b>	



2

#### Kit 2 barre a "T"

- 2 barre da 150 cm (accorciabili)
- 1 attacco a muro
- 2 morsetti di fissaggio al vetro
- 1 raccordo barre

Finitura	Codice	Prezzo
Bianco	<b>R80KUORT150-D</b>	
Silver	<b>R80KUORT150-B</b>	
Cromo	<b>R80KUORT150-K</b>	

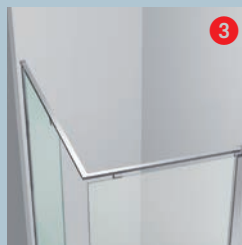

3

#### Sistema di fissaggio EVO

- 1 barra frontale da 180 cm
- 1 barra laterale da 120 cm
- 2 morsetti di fissaggio
- 1 angolare di unione

Finitura	Codice	Prezzo
Silver	<b>KUADHSF-B</b>	
Cromo	<b>KUADHSF-K</b>	

## ESEMPI COMBINAZIONI BARRE DI SOSTEGNO

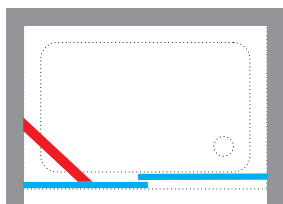

Per questa combinazione ordinare:

- 1 Barra di sostegno orientabile

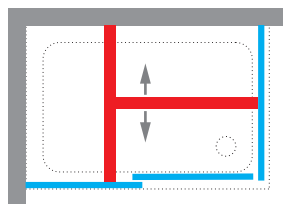

Per questa combinazione ordinare:

- 2 Kit 2 barre a "T" orientabili

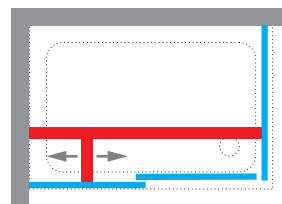

Per questa combinazione ordinare:

- 2 Kit 2 barre a "T" orientabili

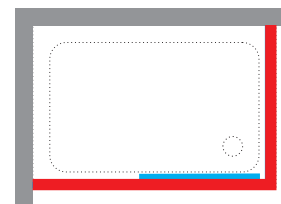

Per questa combinazione ordinare:

- 3 Sistema di fissaggio EVO

## DATI TECNICI

### VETRO TEMPRATO 8 mm (European standards UNI EN 14428)

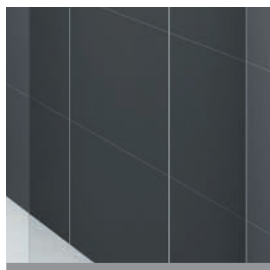

trasparente

COD. 1

### FINITURA PROFILI



cromo

COD. K

### MANIGLIA

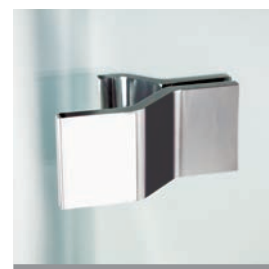

maniglia in metallo  
cromato.

**interasse 30mm**

### MISURE DI INGOMBRO PROFILI DI FISSAGGIO

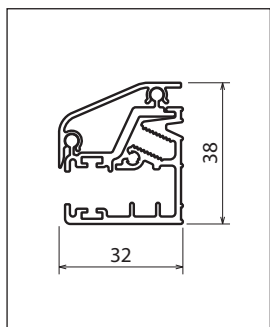

A MURO  
per GALA A / G / 1B / 2P / 2A / R  
**KP01GAMO-K**

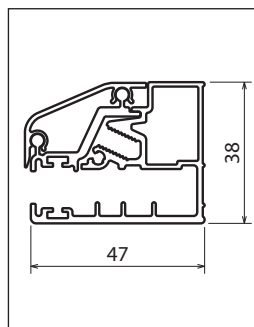

A MURO  
per parete fissa  
**KP01GA1FI-K**

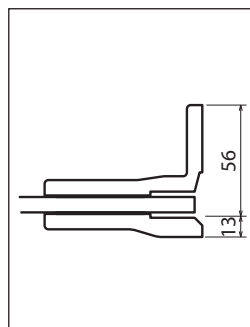

STAFFA A MURO  
per tutti i modelli con staffe  
**SFGA2MO1-K**

Per ulteriori informazioni  
sui profili, vedi pag. 332

### COME RILEVARE LE MISURE

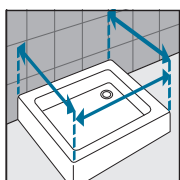
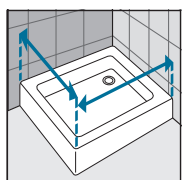

Rilevare le misure da muro a bordo esterno del piatto doccia. Le misure devono essere rilevate sulla parete finita, a rivestimenti posati, secondo gli schemi riportati.

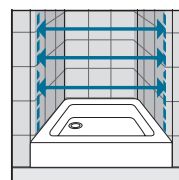

Rilevare le misure da muro a muro, in basso, in alto, al centro e utilizzare quella di valore inferiore. Le misure devono essere rilevate sulla parete finita, a rivestimenti posati, secondo gli schemi riportati.