

DIVINA 35

VASCA RETTANGOLARE, VERSIONE BORDO 3,5 MM

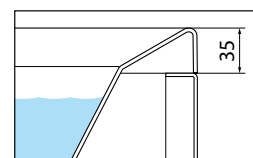

BORDO BASSO - 3,5 CM

Misure		Capacità	Codice	Scelta rubinetteria + finitura vasca				Scelta struttura/pannelli	
Cm	H	lt.		Colonna di scarico con erogazione da troppo pieno		Colonna di scarico + rubinetteria bordo vasca		Solo struttura	Con pannelli
				Bianco lucido	Bianco opaco	Bianco lucido	Bianco opaco	Bianco lucido	Bianco opaco

STANDARD DA INCASSO											
				-A	-U	1-A0K	1-U0K	2-A0K	2-U0K		
160 x 70	63	250	DI116970								
170 x 70	63	280	DI117970								
170 x 75	63	300	DI117975								
180 x 80	63	350	DI118980								
180 x 100	63	430	DI118910								
190 x 90	63	420	DI119990								

STANDARD CON TELAIO											
				-A	-U	1-A	1-U	2-A	2-U	0K	* Vedi tabella SCELTA NUMERO PANNELLI +FINITURA PANNELLI
160 x 70	63	250	DI216970								
170 x 70	63	280	DI217970								
170 x 75	63	300	DI217975								
180 x 80	63	350	DI218980								
180 x 100	63	430	DI218910								
190 x 90	63	420	DI219990								

HYDRO AIR											
				0-A	0-U	1-A	1-U	2-A	2-U	0K	* Vedi tabella SCELTA NUMERO PANNELLI +FINITURA PANNELLI
160 x 70	63	250	DIY169700								
170 x 70	63	280	DIY179700								
170 x 75	63	300	DIY179750								
180 x 80	63	350	DIY189800								
180 x 100	63	430	DIY189100								
190 x 90	63	420	DIY199900								

WHIRLPOOL											
				0-A	0-U	1-A	1-U	2-A	2-U	0K	* Vedi tabella SCELTA NUMERO PANNELLI +FINITURA PANNELLI
160 x 70	63	250	DI5169700								
170 x 70	63	280	DI5179700								
170 x 75	63	300	DI5179750								
180 x 80	63	350	DI5189800								
180 x 100	63	430	DI5189100								
190 x 90	63	420	DI5199900								

HYDRO PLUS											
				0-A	0-U	1-A	1-U	2-A	2-U	0K	* Vedi tabella SCELTA NUMERO PANNELLI +FINITURA PANNELLI
160 x 70	63	250	DI4169700								
170 x 70	63	280	DI4179700								
170 x 75	63	300	DI4179750								
180 x 80	63	350	DI4189800								
180 x 100	63	430	DI4189100								
190 x 90	63	420	DI4199900								



RUBINETTERIA IN COLORE NERO SU RICHIESTA:

Misure			Capacità	Codice	Scelta rubinetteria + finitura vasca						Scelta struttura/pannelli	
Cm	H	lt.			Colonna di scarico senza rubinetteria		Colonna di scarico con erogazione da troppo pieno		Colonna di scarico + rubinetteria bordo vasca		Solo struttura	Con pannelli
					Bianco lucido	Bianco opaco	Bianco lucido	Bianco opaco	Bianco lucido	Bianco opaco		

NATURAL AIR												
				Ø-A	Ø-U	1-A	1-U	2-A	2-U	ØK	* Vedi tabella SCELTA NUMERO PANNELLI + FINITURA PANNELLI	
160 x 70	63	250	DIN169700									
170 x 70	63	280	DIN179700									
170 x 75	63	300	DIN179750									
180 x 80	63	350	DIN189800									
180 x 100	63	430	DIN189100									
190 x 90	63	420	DIN199900									

NATURAL AIR + WHIRLPOOL												
				Ø-A	Ø-U	1-A	1-U	2-A	2-U	ØK	* Vedi tabella SCELTA NUMERO PANNELLI + FINITURA PANNELLI	
160 x 70	63	250	DIP169700									
170 x 70	63	280	DIP179700									
170 x 75	63	300	DIP179750									
180 x 80	63	350	DIP189800									
180 x 100	63	430	DIP189100									
190 x 90	63	420	DIP199900									

Scelta numero pannelli				Scelta finitura pannelli / prezzo							
				LAMINATO		LEGNI					
1 frontale	1 frontale + 1 laterale	1 frontale + 2 laterali	2 frontali + 2 laterali	Bianco Lucido	Bianco Opaco	Bianco rigato	Grain	Burlington	Wenge		
1	2	3	4	A	U	I	M	N	V		
	-	-	-								
-		-	-								
-	-		-								
-	-	-									

SCEGLI ALTRE FINITURE NELLA PAGINA SEGUENTE

Costruzione codice vasca senza pannelli **Codice** + **Scelta scarico/erogazione + Finitura vasca** + **Scelta struttura senza pannelli** = Codice prodotto finale

Costruzione codice vasca con pannelli **Codice** + **Scelta scarico/erogazione + Finitura vasca** + **Scelta struttura con pannelli (acrilico o legni)** = Codice prodotto finale

PER LA VERSIONE CON I PANNELLI IN FINITURA ARGILLA/FRAME ORDINARE: 1 CODICE VASCA SOLO STRUTTURA + 1 CODICE PANNELLI ARGILLA/FRAME (QUI SOTTO)

Misure	Scelta numero pannelli 	Scelta finitura pannelli /prezzo															
		ARGILLA			FRAME NERO OPACO						FRAME BIANCO OPACO						
					LEGNI				ARGILLA		LEGNI			ARGILLA			
		Pece	Polvere	Tortora	Bianco Opaco	Bianco rigato	Grain	Burlington	Pece	Polvere	Tortora	Bianco rigato	Grain	Burlington	Pece	Polvere	Tortora
	1	G	O	S	HU	HI	HM	HN	HG	HO	HS	UI	UM	UN	UG	UO	US
160 x 70	PANV1FDI169-																
170 x 70; 170 x 75	PANV1FDI179-																
180 x 80; 180 x 100	PANV1FDI189-																
190 x 90	PANV1FDI199-																
160 x 70	PANV1F1LDI16970-																
170 x 70	PANV1F1LDI17970-																
170 x 75	PANV1F1LDI17975-																
180 x 80	PANV1F1LDI18980-																
180 x 100	PANV1F1LDI18910-																
190 x 90	PANV1F1LDI19990-																
160 x 70	PANV1F2LDI16970-																
170 x 70	PANV1F2LDI17970-																
170 x 75	PANV1F2LDI17975-																
180 x 80	PANV1F2LDI18980-																
180 x 100	PANV1F2LDI18910-																
190 x 90	PANV1F2LDI19990-																
160 x 70	PANV2F2LDI16970-																
170 x 70	PANV2F2LDI17970-																
170 x 75	PANV2F2LDI17975-																
180 x 80	PANV2F2LDI18980-																
180 x 100	PANV2F2LDI18910-																
190 x 90	PANV2F2LDI19990-																

FRAME SOLO SU PANNELLI FRONTALI

DIVINA

VASCA RETTANGOLARE
Design Massimo Farinatti

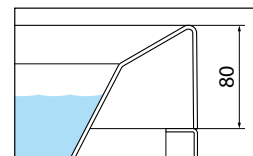

BORDO ALTO - 8 CM

Misure		Capacità	Codice	Scelta rubinetteria + finitura vasca				Scelta struttura/pannelli	
Cm	H	lt.		Colonna di scarico con erogazione da troppo pieno		Colonna di scarico + rubinetteria bordo vasca		Solo struttura	Con pannelli
				Bianco lucido	Bianco opaco	Bianco lucido	Bianco opaco		

STANDARD DA INCASSO

				-A	-U	1-A0K	1-U0K	2-A0K	2-U0K	
160 x 70	63	250	DI116070							
170 x 70	63	280	DI117070							
170 x 75	63	300	DI117075							
180 x 80	63	350	DI118080							
180 x 100	63	430	DI118010							
190 x 90	63	420	DI119090							

STANDARD CON TELAIO

				-A	-U	1-A	1-U	2-A	2-U	0K	*
160 x 70	63	250	DI216070								* Vedi tabella SCelta NUMERO PANNELLI +FINITURA PANNELLI
170 x 70	63	280	DI217070								
170 x 75	63	300	DI217075								
180 x 80	63	350	DI218080								
180 x 100	63	430	DI218010								
190 x 90	63	420	DI219090								

HYDRO AIR

				0-A	0-U	1-A	1-U	2-A	2-U	0K	*
160 x 70	63	250	DIY160700								* Vedi tabella SCelta NUMERO PANNELLI +FINITURA PANNELLI
170 x 70	63	280	DIY170700								
170 x 75	63	300	DIY170750								
180 x 80	63	350	DIY180800								
180 x 100	63	430	DIY180100								
190 x 90	63	420	DIY190900								

WHIRLPOOL

				0-A	0-U	1-A	1-U	2-A	2-U	0K	*
160 x 70	63	250	DI5160700								* Vedi tabella SCelta NUMERO PANNELLI +FINITURA PANNELLI
170 x 70	63	280	DI5170700								
170 x 75	63	300	DI5170750								
180 x 80	63	350	DI5180800								
180 x 100	63	430	DI5180100								
190 x 90	63	420	DI5190900								

HYDRO PLUS

				0-A	0-U	1-A	1-U	2-A	2-U	0K	*
160 x 70	63	250	DI4160700								* Vedi tabella SCelta NUMERO PANNELLI +FINITURA PANNELLI
170 x 70	63	280	DI4170700								
170 x 75	63	300	DI4170750								
180 x 80	63	350	DI4180800								
180 x 100	63	430	DI4180100								
190 x 90	63	420	DI4190900								

NATURAL AIR

				0-A	0-U	1-A	1-U	2-A	2-U	0K	*
160 x 70	63	250	DIN160700								* Vedi tabella SCelta NUMERO PANNELLI +FINITURA PANNELLI
170 x 70	63	280	DIN170700								
170 x 75	63	300	DIN170750								
180 x 80	63	350	DIN180800								
180 x 100	63	430	DIN180100								
190 x 90	63	420	DIN190900								



RUBINETTERIA IN COLORE NERO SU RICHIESTA:

Misure	Capacità	Codice	Scelta rubinetteria + finitura vasca				Scelta struttura/pannelli	
--------	----------	--------	--------------------------------------	--	--	--	---------------------------	--

Colonna di scarico con erogazione da troppo pieno Colonna di scarico + rubinetteria bordo vasca

Bianco lucido Bianco opaco Bianco lucido Bianco opaco Bianco lucido Bianco opaco Solo struttura Con pannelli

NATURAL AIR + WHIRLPOOL											
				0-A	0-U	1-A	1-U	2-A	2-U	0K	* Vedi tabella SCELTA NUMERO PANNELLI +FINITURA PANNELLI
160 x 70	63	250	DIP160700								
170 x 70	63	280	DIP170700								
170 x 75	63	300	DIP170750								
180 x 80	63	350	DIP180800								
180 x 100	63	430	DIP180100								
190 x 90	63	420	DIP190900								

Scelta numero pannelli				Scelta finitura pannelli /prezzo							
				LAMINATO		LEGNI					
1 frontale	1 frontale + 1 laterale	1 frontale + 2 laterali	2 frontali + 2 laterali	Bianco Lucido	Bianco Opaco	Bianco rigato	Grain	Burlington	Wenge		
1	2	3	4	A	U	I	M	N	V		
	-	-	-								
-		-	-								
-	-		-								
-	-	-									

Costruzione codice vasca senza pannelli **Codice** + **Scelta scarico/erogazione + Finitura vasca** + **Scelta struttura senza pannelli** = Codice prodotto finale

Costruzione codice vasca con pannelli **Codice** + **Scelta scarico/erogazione + Finitura vasca** + **Scelta struttura con pannelli (acrilico o legni)** = Codice prodotto finale

PER LA VERSIONE CON I PANNELLI IN FINITURA ARGILLA ORDINARE: 1 CODICE VASCA SOLO STRUTTURA + 1 CODICE PANNELLI ARGILLA (QUI SOTTO)

Misure	Scelta numero pannelli				ARGILLA		
					Pece	Polvere	Tortora
	1 frontale	1 frontale + 1 laterale	1 frontale + 2 laterali	2 frontali + 2 laterali	G	O	S
160 x 70	PANV1FDI160-	-	-	-			
170 x 70; 170 x 75	PANV1FDI170-	-	-	-			
180 x 80; 180 x 100	PANV1FDI180-	-	-	-			
190 x 90	PANV1FDI190-	-	-	-			
160 x 70	-	PANV1F1LDI16070-	-	-			
170 x 70	-	PANV1F1LDI17070-	-	-			
170 x 75	-	PANV1F1LDI17075-	-	-			
180 x 80	-	PANV1F1LDI18080-	-	-			
180 x 100	-	PANV1F1LDI18010-	-	-			
190 x 90	-	PANV1F1LDI19090-	-	-			
160 x 70	-	-	PANV1F2LDI16070-	-			
170 x 70	-	-	PANV1F2LDI17070-	-			
170 x 75	-	-	PANV1F2LDI17075-	-			
180 x 80	-	-	PANV1F2LDI18080-	-			
180 x 100	-	-	PANV1F2LDI18010-	-			
190 x 90	-	-	PANV1F2LDI19090-	-			
160 x 70	-	-	-	PANV2F2LDI16070-			
170 x 70	-	-	-	PANV2F2LDI17070-			
170 x 75	-	-	-	PANV2F2LDI17075-			
180 x 80	-	-	-	PANV2F2LDI18080-			
180 x 100	-	-	-	PANV2F2LDI18010-			
190 x 90	-	-	-	PANV2F2LDI19090-			

DIVINA



VASCA BIANCO MORBIDO CON PANNELLI ARGILLA TORTORA



VASCA BIANCO MORBIDO CON PANNELLI BURLINGTON + FRAME BIANCO

DIVINA | FINITURE PANNELLI

LAMINATO



Bianco lucido Bianco morbido

LEGNO

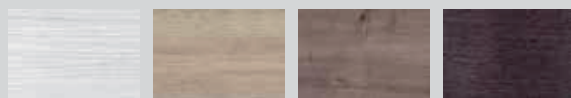

Bianco rigato Grain Burlington Wenge

ARGILLA

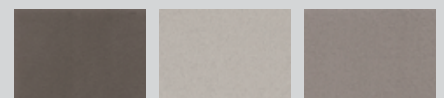

Pece Polvere Tortora

FRAME ALLUMINIO NERO OPACO



Bianco morbido Bianco rigato Grain Burlington

FRAME ALLUMINIO BIANCO OPACO

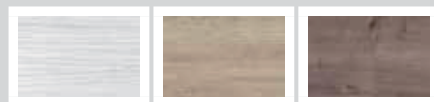

Bianco rigato Grain Burlington

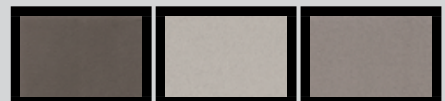

Pece Polvere Tortora

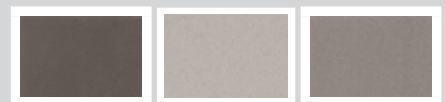

Pece Polvere Tortora

DIVINA | FUNZIONI E DOTAZIONI (disponibili a seconda dell'allestimento)

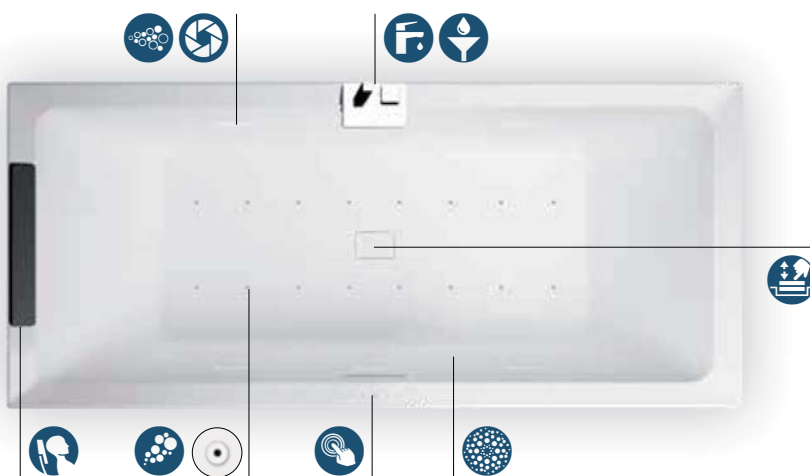

Massaggio Airpool (16 jets) a getto d'aria con accensione manuale on/off. Per una **efficace stimolazione cellulare**.



Massaggio corpo Whirlpool (6 jets) aria/acqua con regolazione di tempo e intensità manuale o automatica. Per soddisfare qualsiasi esigenza di benessere.



Natural air



Cromolight con 8 variazioni cromatiche per attivare la mente ed emozionare lo spirito.



Accensione soft-touch.



Poggiatesta in materiale antibatterico.



Rubinetteria bordo vasca con cascata e tubo di scarico salvagoccia.



Colonna di scarico con piletta click-clack.

OPTIONAL PER VASCHE

POGGIATESTA IN EVA*
per Divina e Divina O



Codice	Prezzo
POGDIV	

POGGIATESTA IN EVA *
per Divina C



Codice	Prezzo
POGDIVC	

POGGIATESTA IN EVA*
per Iris versione in nicchia



Codice	Prezzo
POGIRIN	

POGGIATESTA IN EVA*
per Calos 2.0



Codice	Prezzo
POGCA1	

POGGIATESTA IN EVA *
per Calypso



Codice	Prezzo
POGCAL	

POGGIATESTA IN EVA*
per Vogue



Codice	Prezzo
POGVOG	

**MENSOLINA PORTAOGGETTI
BORDO VASCA**
per Divina, Divina C, O e F



Codice	Prezzo
R90PODIV	

PIANO PORTAOGGETTI SOPRA VASCA
per Divina e Divina F



Larghezza	Codice	Prezzo
70 cm	R90VADIV70	
75 cm	R90VADIV75	
80 cm	R90VADIV80	
90 cm	R90VADIV90	

**PROFILO DI FINITURA RIGIDO
IN ALLUMINIO**



Misure	Codice	Prezzo
1 lato 185 cm	PRV185-30	
2 lati 185x85 cm	PRV18585-30	
3 lati 85x185x85 cm	PRV8518585-30	

*EVA è un materiale atossico, antibatterico e idrorepellente

OPTIONAL PER VASCHE

PROFILO DI FINITURA I. 400 cm



Codice	Prezzo
PRVA2-A	

PROFILO DI FINITURA IN PLASTICA



Codice	Prezzo
PRVA195-30	

TUBO DI SCARICO SALVAGOCCIA



Codice	Prezzo
R90SCDOCBV	

IRIS, CALOS 2.0, UNA, VOGUE, VENUS, CALYPSO

COLONNA DI SCARICO per vasche senza erogatore



Codice	Prezzo
COLSCAVK-K	

COLONNA DI SCARICO CON EROGATORE per vasche con erogatore



Codice	Prezzo
COLSCAE-K	

PANNELLO D'ISPEZIONE PER VASCA AD INCASSO 60x33x2 cm



SENSE

Codice	Prezzo
PANISPEL-A	

IRIS, CALOS 2.0, UNA, VOGUE, VENUS, CALYPSO, BABY

Codice	Prezzo
PANISP-A	

KIT PIEDINI REGOLABILI PER VASCHE AD INCASSO per Sense, Iris, Calos 2.0



Codice	Prezzo
PIEDVASCA	

KIT PIEDINI REGOLABILI per Divina, Calos 2.0, Una, Vogue, Venus, Calypso



Codice	Prezzo
PIEDVASCA70	
PIEDVASCA75	
PIEDVASCA80	
PIEDVASCA90	
PIEDVASCA100	

KIT SOPRAVASCA DIVINA



Per il sopravasca Divina ordinare:

**1 sopravasca Young 2.0 1V/1BSV +
1 kit raccordo vasca**

vedi pag. 580, 582

KIT **HYDROSILENCE**



DIVINA DUAL

Misure	Struttura	Codice	Prezzo
190 x 140	1 Pannello	KUSDIV1F19014	
190 x 140	2 Pannelli	KUSDIV1FL19014	
190 x 140	3 Pannelli	KUSDIV1F2L19014	
190 x 140	4 Pannelli	KUSDIV2F2L19014	

DIVINA C

Misure	Struttura	Codice	Prezzo
140 x 140	1 Pannello	KUSDIVC	

DIVINA O

Misure	Struttura	Codice	Prezzo
165 X 98	1 Pannello	KUSDIVO	

DIVINA 160/170

Misure	Struttura	Codice	Prezzo
160/170	4 Pannelli	KUSDIV2F2L160	

DIVINA 180/190

Misure	Struttura	Codice	Prezzo
180/190	4 Pannelli	KUSDIV2F2L190	

DIVINA - SENSE 3-4

Struttura	Codice	Prezzo
3 Pannelli	KUSDIV1F2L	

DIVINA - SENSE 3-4 ANGOLO

Struttura	Codice	Prezzo
2 Pannelli	KUSDIV1F1L	

DIVINA - SENSE 3-4 NICCHIA

Struttura	Codice	Prezzo
1 Pannello	KUSDIV1F	

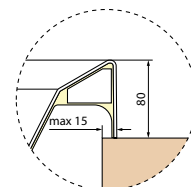
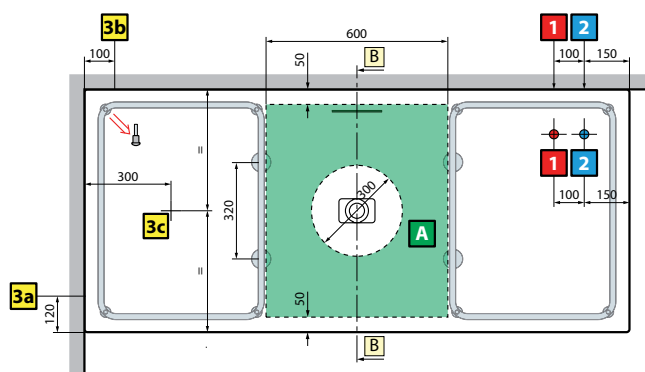
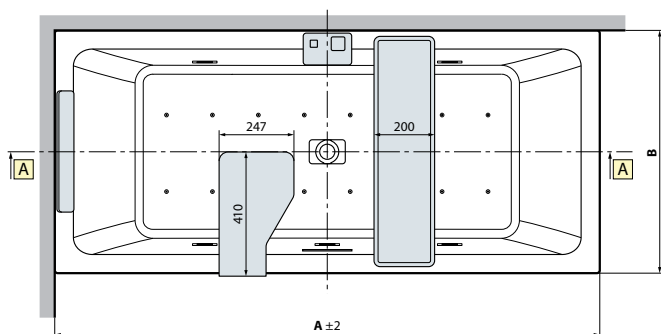
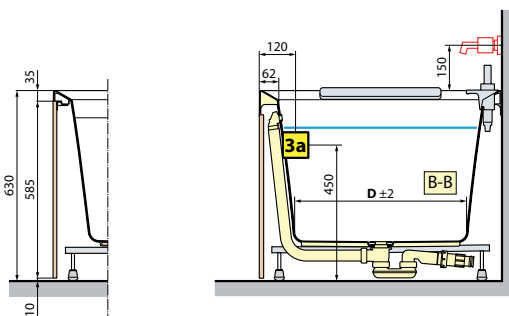
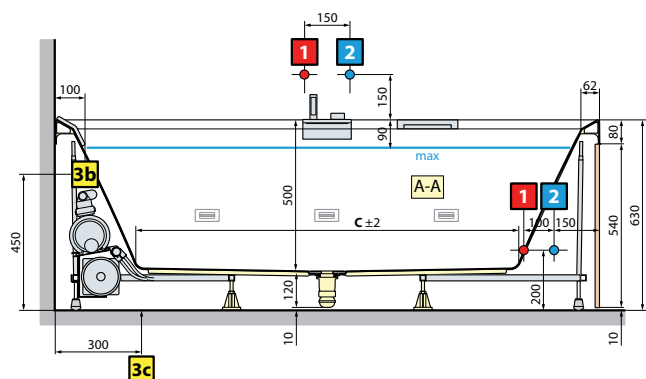

modello	A	B	C	D	Capacità litri
160x70	1600	700	1050	460	250
170x70	1700	700	1150	460	280
170x75	1700	750	1150	510	300
180x80	1800	800	1250	560	350
180x100	1800	1000	1250	760	430
190x90	1900	900	1350	660	420

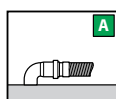
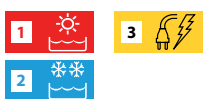

CARATTERISTICHE IDRAULICHE
 16 bocchette airpool
 6 bocchette whirlpool
 Allaccio sifone con raccordo 1 1/2"

CARATTERISTICHE ELETTRICHE
 Tensione 220-230 V
 Frequenza 50 Hz
 Potenza massima assorbita:
 Whirlpool: 900 W
 Airpool: 400 W
 Plus: 1300 W
 Natural Air: 1050 W

Installare a monte dell'apparecchio un interruttore differenziale da 30mA provvisto di interruttore onnipolare con apertura minima dei contatti ≥ 3 mm.

